

APJ ABDUL KALAM
TECHNOLOGICAL
UNIVERSITY

MTECH 2022

KTU

Estd.

Discipline : Civil Engineering
Stream : CE4 (Structural Engineering,
Computer Aided Structural
Engineering)

SEMESTER I

SLOT	COURSE CODE	COURSE NAME	MARKS		L-T-P	HOURS	CREDIT
			CIA	ESE			
A	221TCE100	PROBABILITY AND STATISTICS	40	60	3-0-0	3	3
B	221TCE007	THEORY OF ELASTICITY	40	60	3-0-0	3	3
C	221TCE008	STRUCTURAL DYNAMICS	40	60	3-0-0	3	3
D	221ECEXXX	PROGRAM ELECTIVE 1	40	60	3-0-0	3	3
E	221ECEXXX	PROGRAM ELECTIVE 2	40	60	3-0-0	3	3
S	221RGE100	RESEARCH METHODOLOGY AND IPR	40	60	2-0-0	2	2
T	221LCE003	ADVANCED STRUCTURAL ENGINEERING LAB	100	--	0-0-2	2	1
Total			340	360		19	18

Teaching Assistance: 6 hours

PROGRAM ELECTIVE 1

PROGRAM ELECTIVE 1						
SLOT	SL NO	COURSE CODE	COURSE NAME	L-T-P	HOURS	CREDIT
D	1	221ECE036	ADVANCED THEORY AND DESIGN OF CONCRETE STRUCTURES	3-0-0	3	3
	2	221ECE037	HIGH RISE BUILDINGS	3-0-0	3	3
	3	221ECE038	EXPERIMENTAL METHODS IN STRUCTURAL ENGINEERING	3-0-0	3	3
	4	221ECE039	STRUCTURAL OPTIMIZATION AND RELIABILITY OF STRUCTURES	3-0-0	3	3

PROGRAM ELECTIVE 2

PROGRAM ELECTIVE 2						
SLOT	SL NO	COURSE CODE	COURSE NAME	L-T-P	HOURS	CREDIT
E	1	221ECE042	ADVANCED DESIGN OF STEEL STRUCTURES	3-0-0	3	3
	2	221ECE043	FORENSIC ENGINEERING AND REHABILITATION OF STRUCTURES	3-0-0	3	3
	3	221ECE044	DESIGN OF OFFSHORE STRUCTURES	3-0-0	3	3
	4	221ECE045	ANALYSIS AND DESIGN OF SUBSTRUCTURES	3-0-0	3	3



SEMESTER II

SLOT	COURSE CODE	COURSE NAME	MARKS		L-T-P	HOURS	CREDIT
			CIA	ESE			
A	222TCE100	ADVANCED NUMERICAL METHODS	40	60	3-0-0	3	3
B	222TCE103	FINITE ELEMENT METHOD	40	60	3-0-0	3	3
C	222ECEXXX	PROGRAM ELECTIVE 3	40	60	3-0-0	3	3
D	222ECEXXX	PROGRAM ELECTIVE 4	40	60	3-0-0	3	3
E	222EEXXXX/ 222ECEXXX	INDUSTRY/ INTERDISCIPLINARY ELECTIVE	40	60	3-0-0	3	3
S	222PCE100	MINI PROJECT	100	--	0-0-4	4	2
T	222LCE003	COMPUTATIONAL LAB	100	--	0-0-2	2	1
Total			400	300		21	18

Teaching Assistance: 6 hours

PROGRAM ELECTIVE 3

PROGRAM ELECTIVE 3						
SLOT	SL NO	COURSE CODE	COURSE NAME	L-T-P	HOURS	CREDIT
C	1	222ECE036	STRUCTURAL HEALTH MONITORING	3-0-0	3	3
	2	222ECE037	DESIGN OF BRIDGES	3-0-0	3	3
	3	222ECE038	STABILITY OF STRUCTURES	3-0-0	3	3
	4	222ECE039	THEORY OF PLATES AND SHELLS	3-0-0	3	3

PROGRAM ELECTIVE 4

PROGRAM ELECTIVE 4						
SLOT	SL NO	COURSE CODE	COURSE NAME	L-T-P	HOURS	CREDIT
D	1	222ECE042	ADVANCED COMPOSITE STRUCTURES	3-0-0	3	3
	2	222ECE043	DESIGN OF EARTHQUAKE RESISTANT STRUCTURES	3-0-0	3	3
	3	222ECE044	THEORY OF PLASTICITY	3-0-0	3	3
	4	222ECE045	ENGINEERING FRACTURE MECHANICS	3-0-0	3	3



INTERDISCIPLINARY ELECTIVE

INTERDISCIPLINARY ELECTIVE						
SLOT	SL NO	COURSE CODE	COURSE NAME	L-T-P	HOURS	CREDIT
E	1	222ECE096	NATURAL HAZARDS AND IMPACT MANAGEMENT	3-0-0	3	1
	2	222ECE097	MECHANICS OF COMPOSITE MATERIALS	3-0-0	3	2
	3	222ECE098	PROJECT EVALUATION AND MANAGEMENT	3-0-0	3	3

INDUSTRY ELECTIVE

SEMESTER III

SLOT	COURSE CODE	COURSE NAME	MARKS		L-T-P	HOURS	CREDIT
			CIA	ESE			
TRACK 1							
A*	223MCEXXX	MOOC	To be completed successfully		--	--	2
B	223AGEXXX	AUDIT COURSE	40	60	3-0-0	3	-
C	223ICE100	INTERNSHIP	50	50	--	--	3
D	223PCE100	DISSERTATION PHASE 1	100	--	0-0-17	17	11
TRACK 2							
A*	223MCEXXX	MOOC	To be completed successfully		--	--	2
B	223AGEXXX	AUDIT COURSE	40	60	3-0-0	3	-
C	223ICE100	INTERNSHIP	50	50	---	--	3
D	223PCE001	RESEARCH PROJECT PHASE 1	100	--	0-0-17	17	11
Total			190	110		20	16

Teaching Assistance: 6 hours

*MOOC Course to be successfully completed before the commencement of fourth semester (starting from semester 1).

AUDIT COURSE

AUDIT COURSE						
SLOT	SL NO	COURSE CODE	COURSE NAME	L-T-P	HOURS	CREDIT
B	1	223AGE100	ACADEMIC WRITING	3-0-0	3	-
	2	223AGE001	ADVANCED ENGINEERING MATERIALS	3-0-0	3	-
	3	223AGE002	FORENSIC ENGINEERING	3-0-0	3	-
	4	223AGE003	DATA SCIENCE FOR ENGINEERS	3-0-0	3	-
	5	223AGE004	DESIGN THINKING	3-0-0	3	-
	6	223AGE005	FUNCTIONAL PROGRAMMING IN HASKELL	3-0-0	3	-
	7	223AGE006	FRENCH LANGUAGE (A1 LEVEL)	3-0-0	3	-
	8	223AGE007	GERMAN LANGUAGE (A1 LEVEL)	3-0-0	3	-
	9	223AGE008	JAPANESE LANGUAGE (N5 LEVEL)	3-0-0	3	-
	10	223AGE009	PRINCIPLES OF AUTOMATION	3-0-0	3	-
	11	223AGE010	REUSE AND RECYCLE TECHNOLOGY	3-0-0	3	-
	12	223AGE011	SYSTEM MODELING	3-0-0	3	-
	13	223AGE012	EXPERT SYSTEMS	3-0-0	3	-

SEMESTER IV

SLOT	COURSE CODE	COURSE NAME	MARKS		L-T-P	HOURS	CREDIT
			CIA	ESE			
TRACK 1							
A	224PCE100	DISSERTATION PHASE II	100	100	0-0-24	24	16
TRACK 2							
A	224PCE001	RESEARCH PROJECT PHASE II	100	100	0-0-24	24	16
Total			100	100		24	16

Teaching Assistance: 5 hours

ASSESSMENT PATTERN

(i) CORE COURSES

Evaluation shall only be based on application, analysis or design based questions (for both internal and end semester examinations).

Continuous Internal Evaluation: 40 marks

Micro project/Course based project: 20 marks

Course based task/Seminar/Quiz: 10 marks

Test paper, 1 no: 10 marks

The project shall be done individually. Group projects not permitted. Test paper shall include minimum 80% of the syllabus.

End Semester Examination: 60 marks

The end semester examination will be conducted by the University. There will be two parts; Part A and Part B. Part A contain 5 numerical questions (such questions shall be useful in the testing of knowledge, skills, comprehension, application, analysis, synthesis, evaluation and understanding of the students), with 1 question from each module, having 5 marks for each question. Students shall answer all questions. Part B contains 7 questions (such questions shall be useful in the testing of overall achievement and maturity of the students in a course, through long answer questions relating to theoretical/practical knowledge, derivations, problem solving and quantitative evaluation), with minimum one question from each module of which student shall answer any five. Each question can carry 7 marks. Total duration of the examination will be 150 minutes.

(ii) ELECTIVE COURSES

Evaluation shall only be based on application, analysis or design based questions (for both internal and end semester examinations).

Continuous Internal Evaluation: 40 marks

Preparing a review article based on peer reviewed

Original publications (minimum 10 publications shall be referred) : 15 marks

Course based task/Seminar/Data collection and interpretation : 15 marks

Test paper, 1 no. : 10 marks

Test paper shall include minimum 80% of the syllabus.

End Semester Examination: 60 marks

The end semester examination will be conducted by the respective College. There will be two parts; Part A and Part B. Part A will contain 5 numerical/short answer questions with 1 question from each module, having 5 marks for each question (such questions shall be useful in the testing of knowledge, skills, comprehension, application, analysis, synthesis, evaluation and understanding of the students). Students should answer all questions. Part B will contain 7 questions (such questions shall be useful in the testing of overall achievement and maturity of the students in a course, through long answer questions relating to theoretical/practical knowledge, derivations, problem solving and quantitative evaluation), with minimum one question from each module of which student should answer any five. Each question can carry 7 marks.

Note: The marks obtained for the ESE for an elective course shall not exceed 20% over the average ESE mark % for the core courses. ESE marks awarded to a student for each elective course shall be normalized accordingly. For example if the average end semester mark % for a core course is 40, then the maximum eligible mark % for an elective course is $40+20 = 60\%$.

(iii) RESEARCH METHODOLOGY & IPR/AUDIT COURSE

Continuous Internal Evaluation: 40 marks

Course based task : 15 marks

Seminar/Quiz : 15 marks

Test paper, 1 no. : 10 marks

Test paper shall include minimum 80% of the syllabus.

End Semester Examination: 60 marks

The examination will be conducted by the respective College. The examination will be for 150 minutes and will contain 7 questions, with minimum one question from each module of which student should answer any five. Each question can carry 12 marks.

(iv) LABORATORY COURSES

The laboratory courses will be having only Continuous Internal Evaluation and carries 100 marks. Final assessment shall be done by two examiners; one examiner will be a senior faculty from the same department.

(v) INTERDISCIPLINARY ELECTIVE

Engineering students frequently aspire to work in areas and domains that are key topics in the industry. There are concerns by recruiters that skill sets of engineering students did not match with the Industry requirements, especially in the field of latest topics. In response to their desires, the University has incorporated Industry/Interdisciplinary electives in the curriculum. Interdisciplinary knowledge is critical for connecting students with current industry trends, where multitasking is the norm. Interdisciplinary knowledge aids in the bridge- building process between academic institutions and industry. It aids pupils in expanding their knowledge and innovating by allowing them to create something new. While core engineering courses provide students with a strong foundation, evolving technology necessitates new

methods and approaches to progress, prosperity, and the inculcation of problem-solving techniques. Other courses' knowledge, on the other hand, can assist them to deal with any scenario more effectively. Interdisciplinary courses may be one approach to address such needs, as they can aid in the enhancement of engineering education and the integration of desirable specialized subjects into the current engineering education system. This will enable students to fulfill the current industry demands. Students with multidisciplinary knowledge and projects are more likely to be placed in top industries, according to the placement trend. The future of developing engineers will be influenced by their understanding of emerging technology and interdisciplinary approaches such as bigdata, machine learning, and 3-D printing.

Continuous Internal Evaluation: 40 marks

Preparing a review article based on peer reviewed

Original publications (minimum 10 publications shall be referred) : 15 marks

Course based task/Seminar/Data collection and interpretation : 15 marks

Test paper, 1 no. : 10 marks

Test paper shall include minimum 80% of the syllabus.

End Semester Examination: 60 marks

The end semester examination will be conducted by the respective College. There will be two parts; Part A and Part B. Part A will contain 5 numerical/short answer questions with 1 question from each module, having 5 marks for each question (such questions shall be useful in the testing of knowledge, skills, comprehension, application, analysis, synthesis, evaluation and understanding of the students). Students should answer all questions. Part B will contain 7 questions (such questions shall be useful in the testing of overall achievement and maturity of the students in a course, through long answer questions relating to theoretical/practical knowledge, derivations, problem solving and quantitative evaluation), with minimum one question from each module of which student should answer any five. Each question can carry 7

marks.

(vi) MOOC COURSES

The MOOC course shall be considered only if it is conducted by the agencies namely AICTE/NPTEL/SWAYAM or NITTTR. The MOOC course should have a minimum duration of 8 weeks and the content of the syllabus shall be enough for at least 40 hours of teaching. The course should have a proctored/offline end semester examination. The students can do the MOOC according to their convenience, but shall complete it by third semester. The list of MOOC courses will be provided by the concerned BoS if at least 70% of the course content match with the area/stream of study. The course shall not be considered if its content has more than 50% of overlap with a core/elective course in the concerned discipline or with an open elective.

MOOC Course to be successfully completed before the commencement of fourth semester (starting from semester 1). A credit of 2 will be awarded to all students whoever successfully completes the MOOC course as per the evaluation pattern of the respective agency conducting the MOOC.

(vii) MINIPROJECT

Total marks: 100, only CIA

Mini project can help to strengthen the understanding of student's fundamentals through application of theoretical concepts and to boost their skills and widen the horizon of their thinking. The ultimate aim of an engineering student is to resolve a problem by applying theoretical knowledge. Doing more projects increases problem-solving skills. The introduction of mini projects ensures preparedness of students to undertake dissertation. Students should identify a topic of interest in consultation with PG Programme Coordinator that should lead to their dissertation/research project. Demonstrate the novelty of the project through the results and outputs. The progress of the mini project is evaluated based on three reviews, two interim reviews and a final review. A report is required at the end of the semester.

Interim evaluation: 40 (20 marks for each review), final evaluation by a Committee (will

be evaluating the level of completion and demonstration of functionality/specifications, clarity of presentation, oral examination, work knowledge and involvement): 35, Report (the committee will be evaluating for the technical content, adequacy of references, templates followed and permitted plagiarism level is not more than 25%): 15, Supervisor/Guide: 10

TEACHING ASSISTANCESHIP (TA)

All M Tech students irrespective of their category of admission shall undertake TA duties for a minimum duration as per the curriculum. Being a TA, the student will get an excellent opportunity to improve their expertise in the technical content of the course, enhance communication skills, obtain a hands-on experience in handling the experiments in the laboratory and improve peer interactions.

The possible TA responsibilities include the following: facilitate a discussion section or tutorial for a theory/ course, facilitate to assist the students for a laboratory course, serve as a mentor for students, and act as the course web-master. TAs may be required to attend the instructor's lecture regularly. A TA shall not be employed as a substitute instructor, where the effect is to relieve the instructor of his or her teaching responsibilities (specifically prohibited by University Policy).

For the tutorial session:

- (i) Meet the teacher and understand your responsibilities well in advance, attend the lectures of the course for which you are a tutor, work out the solutions for all the tutorial problems yourself, approach the teacher if you find any discrepancy or if you need help in solving the tutorial problems, use reference text books, be innovative and express everything in English only.
- (ii) Try to lead the students to the correct solutions by providing appropriate hints rather than solving the entire problem yourself, encourage questions from the students, lead the group to a discussion based on their questions, plan to ask them some questions be friendly and open with the students, simultaneously being firm with them.
- (iii) Keep track of the progress of each student in your group, give a periodic feedback to

the student about his/her progress, issue warnings if the student is consistently under-performing, report to the faculty if you find that a particular student is consistently underperforming, pay special attention to slow-learners and be open to the feedback and comments from the students and faculty.

- (iv) After the tutorial session you may be required to grade the tutorials/assignments/tests. Make sure that you work out the solutions to the questions yourself, and compare it with the answer key, think and work out possible alternate solutions to the same question, understand the marking scheme from the teacher. Consult the teacher if are and make sure that you are not partial to some student/students while grading. Follow basic ethics.

Handling a laboratory Session:

- (i) Meet the faculty – in- charge a few days in advance of the actual lab class and get the details of the experiment, get clarifications from him/her regarding all aspects of the experiment and the expectations, prepare by reading about the theoretical background of the experiment, know the physical concepts involved in the experiment, go to the laboratory and check out the condition of the equipment/instrumentation, perform the laboratory experiment at least once one or two days before the actual laboratory class, familiarize with safety/ security aspects of the experiment / equipment/laboratory, prepare an instruction sheet for the experiment in consultation with the faculty, and keep sufficient copies ready for distribution to students for their reference.
- (ii) Verify condition of the equipment/set up about 30 minutes before the students arrive in the class and be ready with the hand outs, make brief introductory remarks about the experiment, its importance, its relevance to the theory they have studied in the class, ask the students suitable questions to know there level of preparation for the experiment, discuss how to interpret results, ask them comment on the results.
- (iii) Correct/evaluate/grade the submitted reports after receiving suitable instructions from the faculty in charge, continue to interact with students if they have any clarifications regarding any aspect of the laboratory session, including of course grading, Carefully observe instrument and human safety in laboratory class, Preparing simple questions for short oral quizzing during explanation of experiments enables

active participation of students, facilitate attention, provides feedback and formative assessment.



APJ ABDUL KALAM
TECHNOLOGICAL
UNIVERSITY

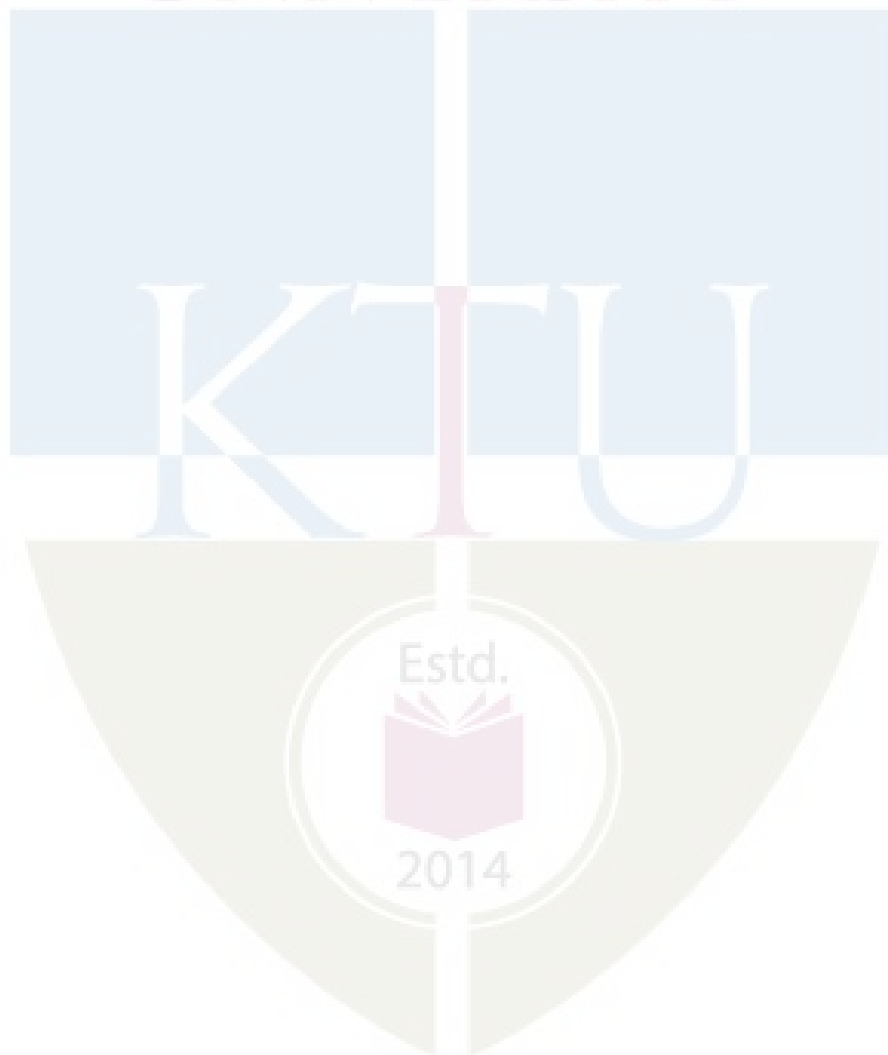

APJ ABDUL KALAM
TECHNOLOGICAL
UNIVERSITY

SEMESTER I

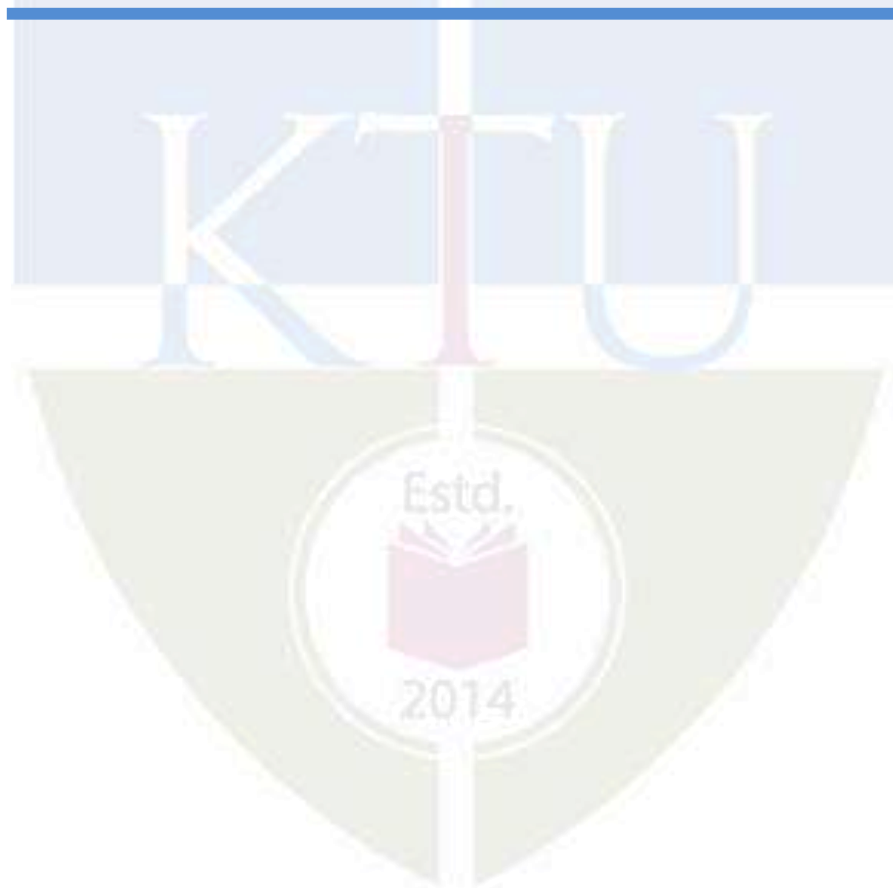

Discipline : CIVIL ENGINEERING
Stream : CE4

CODE	COURSE NAME	CATEGORY	L	T	P	CREDIT
221TCE100	PROBABILITY AND STATISTICS	DISCIPLINE CORE	3	0	0	3

Preamble: The objective of this course is to expose the students to the fundamental concepts of probability and statistics. The course aims to equip the students to find solutions for many real-world civil engineering problems and to understand basic data analysis tools by applying the principles of statistics.

Course Outcomes: After the completion of the course, the student will be able to

CO 1	To create an awareness of the concepts of statistics and probability distributions
CO 2	To formulate and test hypotheses for civil engineering problems
CO 3	To apply statistical data analysis tools such as ANOVA and experimental designs
CO 4	To build regression models for civil engineering applications and to identify the principal components
CO5	To apply the concepts of data analysis for a time series

Mapping of course outcomes with program outcomes

	PO 1	PO 2	PO 3	PO 4	PO 5	PO 6	PO 7
CO 1	3	2		3			2
CO 2	3	2	2	3	3		2
CO 3	3	2	2	3	3		2
CO 4	3	2	2	3	3		2
CO5							

Assessment Pattern

Bloom's Category	End Semester Examination
Apply	25
Analyse	25
Evaluate	5
Create	5

Mark distribution

Total Marks	CIA	ESE	ESE Duration
100	40	60	2.5 hours

Continuous Internal Evaluation: 40 marks

CIVIL ENGINEERING-CE4

Micro project/Course based project : 20 marks

Course based task/Seminar/Quiz : 10 marks

Test paper, 1 no. : 10 marks

The project shall be done individually. Group projects are not permitted. The project may include the implementation of theoretical computation using software packages.

The test papers shall include a minimum 80% of the syllabus.

End Semester Examination: 60 marks

The end semester examination will be conducted by the University. There will be two parts; Part A and Part B. Part A contain 5 numerical questions (such questions shall be useful in the testing of knowledge, skills, comprehension, application, analysis, synthesis, evaluation and understanding of the students), with 1 question from each module, having 5 marks for each question. Students shall answer all questions. Part B contains 7 questions (such questions shall be useful in the testing of overall achievement and maturity of the students in a course, through long answer questions relating to theoretical/practical knowledge, derivations, problem solving and quantitative evaluation), with minimum one question from each module of which student shall answer any five. Each question can carry 7 marks. Total duration of the examination will be 150 minutes.

Syllabus

Module 1- Introduction to probability distributions

Sample Space and Events, Axioms of Probability, Addition rules, Conditional Probability, Multiplication and Total Probability rules, Independence. Random Variables—discrete and continuous random variables, Probability mass functions and probability density functions. Cumulative distribution functions, Mathematical Expectations, mean and variance.

Standard discrete distributions-Binomial and Poisson distribution. Standard continuous distributions –Exponential and Normal distribution, Mean and variance (derivation is not required). Computing probability using the above distributions, Fitting of binomial and Poisson distributions.

Module 2- Statistical Inference

Populations and samples. Sampling distribution of the mean(σ known and unknown), Sampling distribution of the variance(σ known and unknown).Interval estimation:- Confidence interval for mean and variance.-Tests of hypotheses:-Null hypothesis and alternative hypothesis, Type I and Type II errors.-Test of significance of (i) Mean (ii) Mean of two samples (iii)Proportions (iv) Variance (v) Two variance (vi) Paired t-test (vii) Chi-square test of goodness of fit (viii) Chi-square test for independence

Module 3- Analysis of variance

Analysis of variance. Completely randomized designs and randomized block designs.- Latin square designs -Factorial experiments: Two-factor experiments (overview only)

Module 4- Correlation and regression models

Linear regression and correlation, method of least squares, normal regression analysis, normal correlation analysis, correlation coefficient- Multiple linear regression, normal equations -Principal components (brief overview only)

Module 5-Time Series Models

Components of time series. Identifying linear trend: semi averages method and least squares method. Smoothing: moving averages, weighted moving averages, exponential smoothing using one smoothing coefficient. Forecasting, measuring forecasting accuracy

Course Plan

No	Topic	No. of Lectures
1	Introduction to probability distributions	
1.1	Sample Space and Events, Axioms of Probability, Addition rules, Conditional Probability, Multiplication and Total Probability rules, Independence.	1
1.2	Random Variables–discrete and continuous random variables, Probability mass functions and probability density functions. Cumulative distribution functions, Mathematical Expectations, mean and variance.	2
1.3	Standard discrete distributions-Binomial and Poisson distribution. Standard continuous distributions –Exponential and Normal distribution, Mean and variance (derivation is not required). Computing probability using the above distributions, Fitting of binomial and Poisson distributions.	5
2	Statistical Inference	
2.1	Populations and samples. Sampling distribution of the mean(σ known and unknown), Sampling distribution of the variance(σ known and unknown).Interval estimation:- Confidence interval for mean and variance.	2
2.2	Tests of hypotheses:-Null hypothesis and alternative hypothesis, Type I and Type II errors.	2

2.3	Test of significance of (i) Mean (ii) Mean of two samples (iii) Proportions (iv) Variance (v) Two variance (vi) Paired t-test (vii) Chi-square test of goodness of fit (viii) Chi-square test for independence	4
3	Analysis of variance	
3.1	Analysis of variance. Completely randomized designs and randomized block designs.	4
3.2	Latin square designs	2
3.3	Factorial experiments: Two-factor experiments (overview only)	2
4	Correlation and regression models	
4.1	Linear regression and correlation, method of least squares, normal regression analysis, normal correlation analysis, correlation coefficient	4
4.2	Multiple linear regression, normal equations	2
4.3	Principal components (brief overview only)	2
5	Time Series Models	
5.1	Components of time series. Identifying linear trend: semi averages method and least squares method.	2
5.2	Smoothing: moving averages, weighted moving averages, exponential smoothing using one smoothing coefficient.	3
5.3	Forecasting, measuring forecasting accuracy	3
	Total hours	40

Reference Books

1. Gupta. S. C. and Kapoor. V. K, Fundamentals of Mathematical Statistics, Sultan Chand and Sons, 2020
2. Benjamin, Jack.R and Comell.C, Allin, Probability, Statistics and Decision for Civil Engineers, Mc- McGraw-Hill.
3. Johnson RA , Miller I, Freund J. Miller and Freund's Probability and Statistics for Engineers (9th edition) Pearson. 2018.
4. Response Surface Methodology: Process and Product Optimization Using Designed Experiments, 4th Edition Raymond H. Myers, Douglas C. Montgomery, Christine M. Anderson-Cook ISBN: 978-1-118-91601-8 February 2016.
5. Introduction to Time Series Analysis and Forecasting Second Edition, DOUGLAS C. MONTGOMERY, CHERYL L. JENNINGS, MURAT KULAHCI, John Wiley & Sons, 2015.
6. Papoulis A, Pillai SU Probability, Random Variables and Stochastic Processes McGraw Hill 2022
7. Schiller J, Srinivasan RA, Spiegel M Schaum's Outline of Probability and Statistics, 2012 McGraw Hill
8. Ross S Introduction to Probability and Statistics for Engineers and Scientists Elsevier 6th Edition 2021

XXXX PROBABILITY AND STATISTICS

Time: 3 Hrs

Max. Marks:60

PART A*(Answer all Questions: Each question carries 5 marks)*

1. Explain the concept of mean, median and mode, and its applicability in various contexts with suitable examples.
2. Explain Type I and Type II errors with example.
3. What are the assumptions involved in Analysis of Variance (ANOVA)?
4. Obtain Karl Pearson's correlation coefficient for Stress and Performance.

Observation no.	1	2	3	4	5
Performance	75	80	85	90	95
Stress	80	75	80	60	55

5. Explain briefly the components of time series.

PART B*(Answer any five questions: Each carry 7 marks)*

6. The number of products sold by a shop keeper follows Poisson distribution, with a mean of 2 per week. (i) Find the Probability that in the next 4 weeks the shop keeper sells exactly 3 products. (ii) The shop keeper monitors sales in periods of 5 weeks. Find the probability that in the next 15 of these 5-week period, there are exactly 10 periods in which more than 5 products are sold.
7. After conducting series test on Probability and Statistics the following scores were obtained for Batch A and Batch B. Conduct a hypothesis testing for checking the equality of variance in scores of two batches at a significant level corresponding to a β error probability of 0.9.

A	35	40	42	30	12	50	45	28	26	30
B	20	24	28	26	18	50	50	48	48	09

8. In order to evaluate safety performance of employees across 3 departments, 5 employees across each department were randomly monitored and their safety behaviour on a hundred scale is given below. Do the departments differ in their safety behaviour?

Department	1	2	3	4	5
A1	68	73	75	65	78
A2	85	85	78	86	79
A3	73	77	72	70	76

9. Develop a Regression Equation between A and B using Method of Least Square. Consider B as the dependent variable. Explain the significance of estimated slope.

Observation no.	1	2	3	4	5
A	75	80	85	90	95
B	80	75	80	60	55

10. Foodgrain production (in lakh tones) is given below. Find the Trend by using 3-yearly and 4-yearly moving average method, tabulate the trend values and predict the production for the year 2022.

Years	Production
2008	40
2009	60
2010	45
2011	85
2012	130
2013	135
2014	150
2015	120
2016	200

11. An evaluation of teaching methods shows the following outcomes.

Method of Teaching	No of students	Average marks obtained	Population Standard Deviation
Chalk and Talk Method	32	70	5
PPT and Talk Method	29	65	8

Conduct hypothesis testing for the mean difference of the teaching methods at a significant level corresponding to a Type I error probability of 0.01.

CODE	COURSE NAME	CATEGORY	L	T	P	CREDIT
221TCE007	THEORY OF ELASTICITY	PROGRAM CORE 1	3	0	0	3

Preamble: This course advances students from the one-dimensional and linear solid mechanics problems, conventionally treated in courses of strength of materials, into more general, two and three-dimensional problems. Students will be introduced to rectangular and polar coordinate systems to describe stress and strain in an elastic continuum and also solve various 2D linear elastic problems.

Course Outcomes: After the completion of the course the student will be able to

CO 1	Apply knowledge of mechanics and mathematics to model elastic bodies as continuum.
CO 2	Formulate boundary value problems; and calculate stresses and strains.
CO 3	Comprehend constitutive relations for elastic solids and compatibility constraints.
CO 4	Solve two-dimensional problems (plane stress and plane strain) using the concept of stress function.

Mapping of course outcomes with program outcomes

	PO 1	PO 2	PO 3	PO 4	PO 5	PO 6	PO 7
CO 1	3	2	3	3	3	3	1
CO 2	3	2	3	3	3	3	1
CO 3	3	2	3	3	3	3	1
CO 4	3	2	3	3	3	3	1

Assessment Pattern

Bloom's Category	Continuous Assessment test	End Semester Examination
Understand	10	15
Apply	10	15
Analyse	20	30
Evaluate	-	-
Create	-	-

Mark distribution

Total Marks	CIE	ESE	ESE Duration
100	40	60	2.5 hours

Continuous Internal Evaluation Pattern:

Continuous Internal Evaluation: 40 marks

Micro project/Course based project : 20 marks

Course based task/Seminar/Quiz : 10 marks

Test paper, 1 no. : 10 marks

The project shall be done individually. Group projects not permitted. Test paper shall include minimum 80% of the syllabus.

End Semester Examination Pattern:

The end semester examination will be conducted by the University. There will be two parts; Part A and Part B. Part A contain 5 numerical questions (such questions shall be useful in the testing of knowledge, skills, comprehension, application, analysis, synthesis, evaluation and understanding of the students), with 1 question from each module, having 5 marks for each question. Students shall answer all questions. Part B contains 7 questions (such questions shall be useful in the testing of overall achievement and maturity of the students in a course, through long answer questions relating to theoretical/practical knowledge, derivations, problem solving and quantitative evaluation), with minimum one question from each module of which student shall answer any five. Each question can carry 7 marks. Total duration of the examination will be 150 minutes.

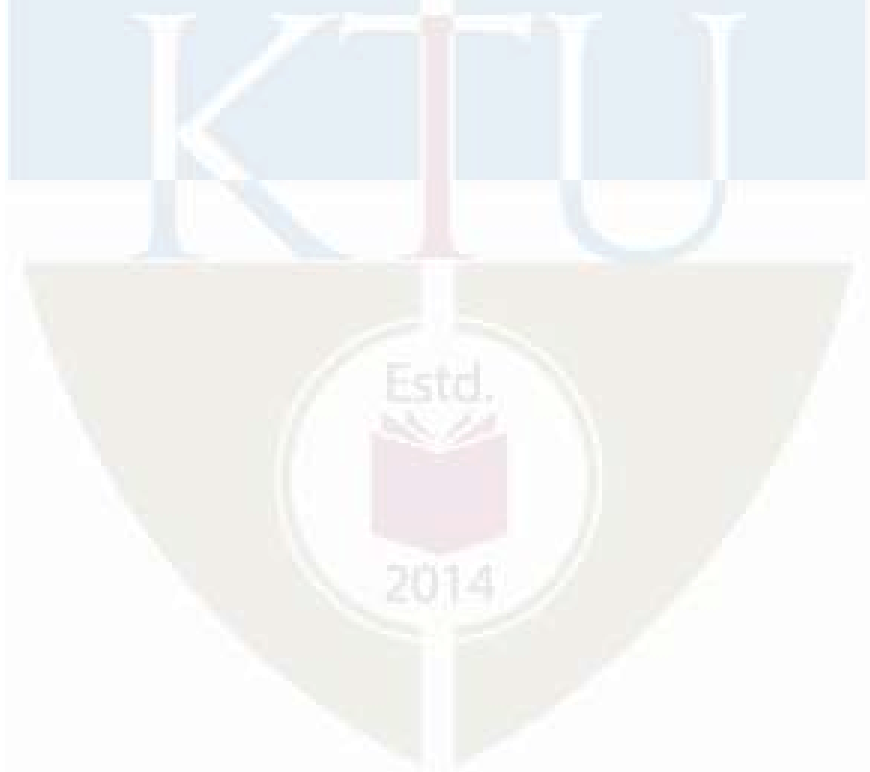

Model Question Paper

Max. Marks: 60

Duration: 2.5 Hours

PART A*Answer all questions; each question carries 5 marks*

1. A rectangular metal bar of cross-section $30 \text{ mm} \times 25 \text{ mm}$ is subjected to an axial tensile force of 150 kN. Calculate the normal, shear and resultant stresses on a plane whose normal has the following direction cosines: $l = m = 1/\sqrt{2}$ and $n = 0$.
2. Demonstrate the systematic reduction in the number of independent elastic constants from a general anisotropic material to isotropic material.
3. State and explain the principle of stationary potential energy and complementary energy.
4. Show that the function $\phi = A \left(xy^3 - \frac{3}{4} xyh^2 \right)$ is an Airy's stress function. Also calculate and define the stress components on a rectangular domain of width b and depth h .
5. Determine the shear stress induced and the angle of twist per unit length of a hollow shaft of uniform wall thickness 5 mm with cross section dimensions 80 mm (width) \times 20 mm (depth), when subjected to a torque of 1kN-m. The modulus of rigidity $G = 1.3 \times 10^4 \text{ MPa}$.

PART B*Answer any five questions; each question carries 7 marks*

6. The state of stress at a point in a stressed body is given below:

$$\sigma = \begin{bmatrix} 10 & 4 & 6 \\ 4 & 2 & 8 \\ 6 & 8 & 6 \end{bmatrix} \text{ MPa}$$

- (i) Find the principal planes and principal stresses corresponding to the above stress state. (4 marks)
 - (ii) Also determine the normal and shear stresses on an octahedral plane. (3 marks)
7. The displacement field in a homogenous isotropic elastic body is given by $u = 1 \times 10^{-6} [(3x^2z + 60x)i + (5z^2 + 10xy)j + (6z^2 + 2xyz)k]$.
 - (i) Determine the strain components. (3 marks)
 - (ii) If the coordinate axes are rotated about the z -axis through 45° in the anticlockwise direction, determine the new strain components. (4 marks)

8. Derive the Navier equations for 3D elasticity problems. (7 marks)
CIVIL ENGINEERING-CE4
9. Explain in detail any three failure theories. (7 marks)
10. Using stress function approach, derive an expression for the maximum deflection of a simply supported beam of length l and depth $2c$, if the beam is subjected to a uniformly distributed load of intensity q . (7 marks)
11. Derive the expressions for the maximum shear stress in a bar of elliptical cross-section subjected to torque. Also plot the contour lines for displacement. (7 marks)
12. Figure 1 shows a two cell tubular section having one interior web. An external torque of 10,000 N-m is acting in a clockwise direction. Determine the distribution of internal shear flow. The peripheral lengths are as shown in figure. The cell areas are as follows: $A_1 = 800 \text{ cm}^2$ and $A_2 = 1780 \text{ cm}^2$.

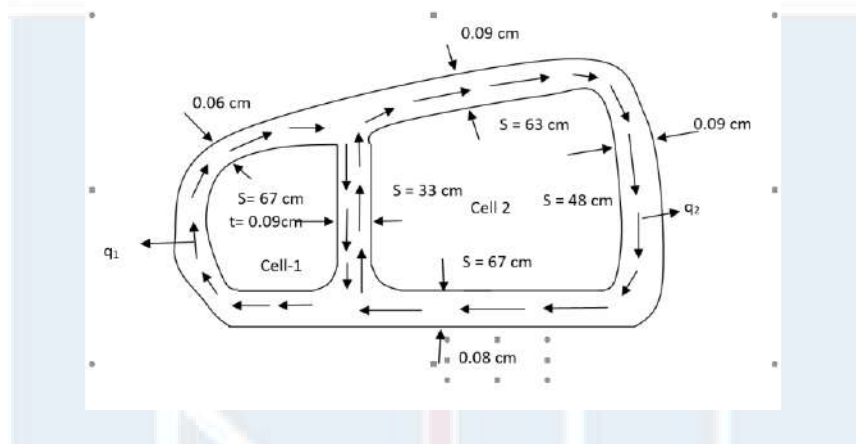

Fig.1



Syllabus and Course Plan (For 3 credit courses, the content can be for 40 hrs and for 2 credit courses, the content can be for 26 hrs. The audit course in third semester can have content for 30 hours).

CIVIL ENGINEERING-CE4

No	Topic	No. of Lectures
	Review of the topics in the undergraduate course Mechanics of Solids from a slightly advanced point of view.	1 Hr.
1	Analysis of 3D state of stress	
1.1	Definition of stress at a point – Notation and sign conventions for stress Stress tensor.	1 Hr.
1.2	Differential equations of equilibrium and numerical examples	1 Hr.
1.3	Stress components on an arbitrary plane – stress transformations.	1 Hr.
1.4	Numerical examples on stress transformations and Traction boundary conditions	1 Hr.
1.5	Principal planes and principal stresses -stress invariants.	1 Hr.
1.6	State of stress referred to the principal coordinate system – stress ellipsoid – octahedral stresses.	1 Hr.
1.7	Maximum shear stress, Hydrostatic and Deviatoric Stress, Numerical examples	1 Hr.
2	Analysis of 3D state of strain and Constitutive relations	
2.1	Displacement field and strain field – elementary concept of strain.	1 Hr.
2.2	Strain-displacement relations for small deformations,	1 Hr.
2.3	Compatibility conditions – numerical examples	1 Hr.
2.4	Strain transformations; Principal strains	1 Hr.
2.5	Strain invariants, Octahedral strains, Hydrostatic and deviatoric components of strain.	1 Hr.
2.6	Generalized Hooke's law: Reduction in number of elastic constants: general anisotropy, orthotropy and isotropy.	1 Hr.
3	Boundary value problems of elasticity, energy theorems and failure theories	
3.1	Boundary value problems of elasticity- Displacement, Traction and Mixed types.	1 Hr.
3.2	Navier equations and Beltrami-Michell's Equations.	1 Hr.
3.3	St.Venant's principle, Uniqueness of solutions.	1 Hr.
3.3	Energy theorems - Strain energy and Complimentary energy.	1 Hr.
3.4	Principle of stationary potential energy and minimum complementary energy.	1 Hr.
3.5	Principle of virtual work for deformable bodies – illustrative examples	1 Hr.
3.6	Failure theories or Yield criteria: Maximum principle stress theory, Maximum shear stress theory, Maximum normal strain theory.	1 Hr.
3.7	Octahedral shear stress theory, Maximum elastic energy theory, Maximum distortion energy theory.	1 Hr.
4	Two-Dimensional Problems of Elasticity	

4.1	Plane stress and plane strain problems	1 Hr.
4.2	Solution of plane problems in rectangular coordinates- stress function approach	1 Hr.
4.3	Airy's stress function and Biharmonic equation in rectangular coordinates; Solution by polynomials – Numerical examples.	1 Hr.
4.4	Elasticity solution for bending of cantilever loaded at free end	1 Hr.
4.5	Elasticity solution for bending of Uniformly loaded simply supported beam.	1 Hr.
4.6	2D problems in polar coordinates - Equations of equilibrium in polar coordinates	1 Hr.
4.7	Strain displacement, compatibility and stress-strain relations in polar coordinates	1 Hr.
4.8	Stress function approach for solution of 2D problems in polar coordinates- Airy's stress function and Biharmonic equations	1 Hr.
4.9	Problems of axisymmetric stress distributions- Thick cylinders subjected to internal and external pressures.	1 Hr.
4.10	Stress concentrations due to circular hole in plates	1 Hr.
5	Torsion of noncircular bars	
5.1	St.Venant's Semi-inverse method	1 Hr.
5.2	Prandtl's stress function approach	1 Hr.
5.3	Stress function approach for solution of torsion of bars of elliptical cross section	1 Hr.
5.4	Stress function approach for solution of torsion of bars with triangular cross section	1 Hr.
5.5	Prandtl's membrane analogy.	1 Hr.
5.6	Membrane analogy application to prismatic bars of narrow rectangular cross-section and thin-walled open sections.	1 Hr.
5.7	Torsion of thin-walled single cell hollow closed sections	1 Hr.
5.8	Torsion of thin-walled multiple cell closed sections.	1 Hr.

Reference Books

1. Timoshenko S.P. and J. Goodier, McGraw-Hill.
2. Ugural A. C. and S. K. Fenster, "Advanced Strength and Applied Elasticity", Prentice Hall.
3. Ragab A.R. and S.E. Bayoumi, Engineering Solid Mechanics, Fundamentals and Applications, CRC Press New York.
3. Boresi A.P. and R. J. Shimidt, Advanced Mechanics of Materials, John Wiley & Sons, Pvt. Ltd.
4. Srinath L.S., Advanced Mechanics of Solids, Tata McGraw-Hill publishing company, NewDelhi.
5. Sadd. M., Elasticity: Theory, Applications and Numerics, Elsevier.
6. C. T. Wang, "Applied Elasticity", Mc-Graw Hill Book Company, New York.

CODE	COURSE NAME	CATEGORY	L	T	P	CREDIT
221TCE008	STRUCTURAL DYNAMICS	PROGRAM CORE 2	3	0	0	3

Preamble: The course provides the basic concepts of structural dynamics and the theoretical background to perform dynamic analysis of structures. The course focuses on analysis of single and multi-degree of freedom systems. An introduction to distributed parameter system is also included. The course also provides an introduction to earthquake analysis of structures.

Course Outcomes: After the completion of the course on Structural Dynamics, the student will be able to

CO 1	Model single and multi-degree freedom systems for dynamic analysis and develop equations of motion
CO 2	Estimate parameters of dynamic systems
CO 3	Perform dynamic analysis of single degree freedom systems
CO 4	Perform dynamic analysis of multi - degree freedom systems
CO 5	Analyse and design vibration isolation systems
CO 6	Perform dynamic analysis of distributed parameter systems

Mapping of course outcomes with program outcomes

	PO 1	PO 2	PO 3	PO 4	PO 5	PO 6	PO 7
CO 1	3		2				
CO 2	3		2				
CO 3	2		2		1		
CO 4	1		1		1		
CO 5	1		1	1	1		
CO 6	1		1		1		

(1-Weak, 2-Medium, 3- strong)

Assessment Pattern

Bloom's Category	End Semester Examination
Apply	46
Analyse	14
Evaluate	-
Create	-

Mark distribution

Total Marks	CIE	ESE	ESE Duration
100	40	60	2.5 hours

Continuous Internal Evaluation Pattern:

Micro project/Course based project: 20 marks

Course based task/Seminar/Quiz: 10 marks

Test paper, 1 no.: 10 marks

The project shall be done individually. Group projects not permitted.

Test paper shall include minimum 80% of the syllabus

End Semester Examination Pattern:

The end semester examination will be conducted by the University. There will be two parts; Part A and Part B. Part A contain 5 numerical questions (such questions shall be useful in the testing of knowledge, skills, comprehension, application, analysis, synthesis, evaluation and understanding of the students), with 1 question from each module, having 5 marks for each question. Students shall answer all questions. Part B contains 7 questions (such questions shall be useful in the testing of overall achievement and maturity of the students in a course, through long answer questions relating to theoretical/practical knowledge, derivations, problem solving and quantitative evaluation), with minimum one question from each module of which student shall answer any five. Each question can carry 7 marks. Total duration of the examination will be 150 minutes.

Model Question Paper

QP CODE:

Reg No.: _____

Name: _____

**APJ ABDUL KALAM TECHNOLOGICAL UNIVERSITY FIRST SEMESTER
M.TECH. DEGREE EXAMINATION,**

MONTH & YEAR

Course Code: 221TCE008

STRUCTURAL DYNAMICS

Max. Marks: 60

Duration: 2.5 hours

PART A

(Answer *ALL* questions; each question carries 5 marks)

1. Calculate the natural frequency of transverse vibrations of a cantilever beam 40mm diameter circular cross section, carrying a load of 500N at the free end. Span of the cantilever is 800mm. $E = 200\text{GPa}$. If a spring of stiffness 52.75kN/m is introduced between the mass and the beam calculate the change in natural frequency.
2. A sieving machine weighs 2500kg and when operating at full capacity, it exerts a harmonic force of 3kN amplitude at 20Hz on its supports. After mounting the machine on spring type vibration isolators, it was found that the harmonic force exerted on the supports had been reduced to a 250N amplitude. Determine the stiffness of the isolator springs. Take $\zeta = 10\%$.
3. Two pendulum bobs are suspended from the ceiling using massless rigid bars and the bars are connected using a spring as shown in figure. Derive the equation of motion for small oscillations. Write down the mass and stiffness matrices of the system. Take $m_1 = 2.0\text{kg}$, $m_2 = 1.5\text{kg}$, $L_1 = 1.5\text{m}$, $L_2 = 1.0\text{m}$, $a = 0.5\text{m}$, $k = 150\text{N/m}$.

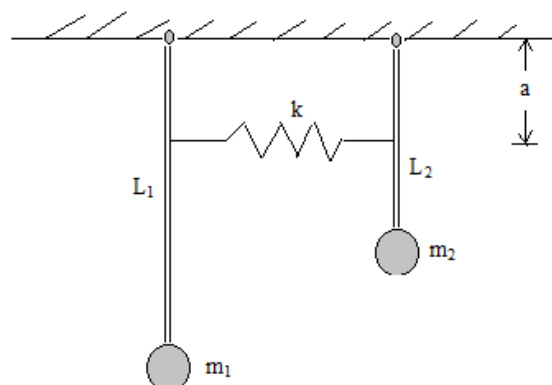

4. Establish the equation of motion for the frame shown in figure, if it is subjected to a suddenly applied constant acceleration $0.28g$ at its base. Take $m_1 = 10\text{kg}$, $m_2 = 20\text{kg}$, $k = 1500\text{N/m}$, $k_c = 2000\text{N/m}$.

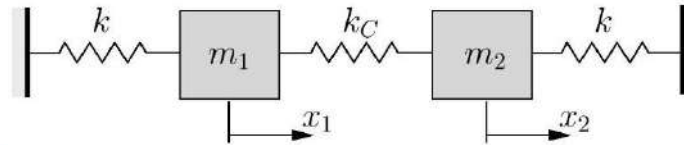

5. Obtain the equation of motion of a SDOF system shown in figure using Lagrange's equation. Take $m = 10\text{kg}$ and $k = 5000\text{N/m}$.

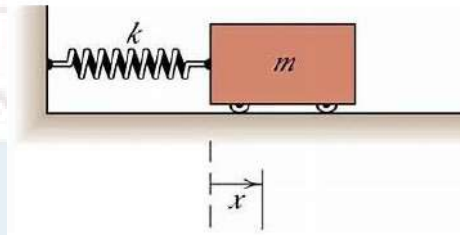

PART B

(Answer **any FIVE** questions; each question carries 7 marks)

6. Determine the parameters in an equivalent model of the system as shown in the figure when θ , the clockwise angular displacement of the bar from the system's equilibrium position, is used as generalized coordinate. Assume small θ .

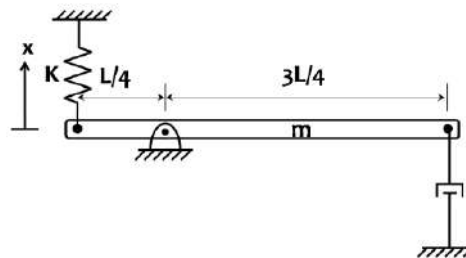

7. One of the construction companies hires you to determine the dynamic properties of a frame system for which it has lost the original blue prints. Being a civil engineer, you were assigned to do a free vibration test of the frame system. Supplied with a hydraulic jack, you were able to apply a jacking force to displace the frame. With a jacking force of 134kN , you noted down that the frame has displaced 0.76cm . On the first return swing after release, the frame did not come back to the release point but rather it stopped at 0.64cm towards it. You recorded time between the release and the first return as 2s . Determine the following
- Weight of the frame
 - Natural frequency
 - Logarithmic decrement
 - Damping ratio
 - Damping frequency
 - Amplitude of the frame after 6 cycles

8. A frame is subjected to harmonic loading as shown in figure. If $P_0 = 20\text{kN}$, calculate the dynamic amplification factor and amplitude of steady state response for the following cases. (i) $\lambda = 10\text{rad/s}$, (ii) $\lambda = 15\text{rad/s}$, (iii) $\lambda = 20\text{rad/s}$. Comment on the results. Take $\zeta = 5\%$ and $EI = 10^{10}\text{kNmm}^2$.

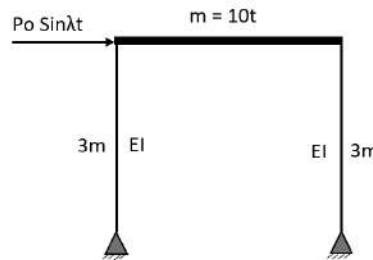

9. Derive the expression for the response of a SDOF system subjected to a rectangular impulse of duration t_1 and magnitude P_0 .
10. State and prove the orthogonality condition of normal modes in a MDOF system.
11. Explain mode superposition method of analysis.
12. Derive the differential equation governing the flexural vibration of beams. How will you find the undamped free vibration solution? Demonstrate for a simply supported beam of span L having uniform flexural rigidity EI and mass per unit length.

Syllabus

Module 1

Vibration studies and its importance to structural engineering applications – Types of dynamic loading – Systems with single degree of freedom – Elements of a vibratory system – Mathematical model for single degree of freedom systems - Equation of motion. Undamped and damped free vibration of single degree of freedom system. Measurement of damping from free vibration response - Logarithmic decrement.

Module 2

Response of single degree of freedom systems to harmonic loading, Measurement of damping from forced response – Half power band width method. Impulse response function, Response of single degree of freedom systems subjected to impulse, periodic and general loading- Duhamel integral. Single degree freedom subjected to support motion. Vibration isolation –Transmissibility.

Module 3

Multi-degree of freedom systems – Equation of motion. Shear building concept and models for dynamic analysis –Evaluation of natural frequencies and mode shapes by solution of characteristic equation. Co-ordinate coupling - Orthogonality of normal modes.

Module 4

Forced vibration analysis of multi-degree of freedom systems - Mode superposition method of analysis. Response of multi degree of freedom systems to support motion.

Module 5

Distributed mass (continuous) systems – differential equation of motion – Axial vibration of rods. Flexural vibration of beams, natural frequencies and mode shapes of simply supported beam. Evaluation of frequencies and mode shapes of cantilever beam and fixed beam (formulation only) –Variational formulation of the equation of motion – Hamilton’s principle - Lagrange’s equation.

Course Plan

No	Topic	No. of Lectures
1	Introduction to Dynamics and Free Vibration of SDOF Systems (9)	
1.1	Vibration studies and its importance to structural engineering applications – Types of dynamic loading – Systems with single degree of freedom – Elements of a vibratory system – Mathematical model for single degree of freedom systems - Equation of motion.	4
1.2	Undamped and damped free vibration of single degree of freedom system.	4
1.3	Measurement of damping from free vibration response - Logarithmic decrement.	1
2	Forced Vibration of SDOF Systems (11)	
2.1	Response of single degree of freedom systems to harmonic loading, Measurement of damping from forced response – Half power band width method.	3
2.2	Impulse response function, Response of single degree of freedom systems subjected to impulse (rectangular, triangular and half sine wave), periodic and general loading- Duhamel integral.	4
2.3	Single degree freedom subjected to support motion.	2
2.4	Vibration isolation –Transmissibility	2
3	Free vibration of MDOF Systems (7)	
3.1	Multi-degree of freedom systems – Equation of motion.	1
3.2	Shear building concept and models for dynamic analysis – Evaluation of natural frequencies and mode shapes by solution of characteristic equation.	5
3.3	Co-ordinate coupling - Orthogonality of normal modes.	1
4	Forced Vibration of MDOF Systems (7)	

4.1	Forced vibration analysis of multi-degree of freedom systems - Mode superposition method of analysis.	4
4.2	Response of multi degree of freedom systems to support motion.	3
5	Distributed Parameter Systems (6)	
5.1	Distributed mass (continuous) systems – differential equation of motion – Axial vibration of rods.	1
5.2	Flexural vibration of beams, natural frequencies and mode shapes of simply supported beam. Evaluation of frequencies and mode shapes of cantilever beam and fixed beam (formulation only).	4
5.3	Variational formulation of the equation of motion – Hamilton's principle - Lagrange's equation.	1

Reference Books

1. Clough R W and Penzien J, Dynamics of Structures, McGraw Hill, New Delhi.
2. Biggs J M, Introduction to Structural dynamics, McGraw Hill, New Delhi.
3. Mario Paz, Structural Dynamics – Theory and Computation, CBS Publishers and Distributors, Delhi.
4. Mukhopadhyay M, Structural Dynamics - Vibrations and Systems, Ane Books India, Delhi.
5. Humar J, Dynamics of Structures, CRC Press, Netherlands.
6. Anil K Chopra, Dynamics of Structures- Theory and Application to Earthquake Engineering, Pearson Education, New Delhi.
7. Roy R Craig, Structural Dynamics – An Introduction to Computer Method, John Wiley & Sons, Newyork.
8. Thomson W T, Theory of Vibration with Application, Pearson Education, New Delhi.
9. Weaver W, Timoshenko S P, Young D H, Vibration Problems in Engineering, John Wiley & Sons, USA.

CODE	COURSE NAME	CATEGORY	L	T	P	CREDIT
221LCE003	ADVANCED STRUCTURAL ENGINEERING LAB	LABORATORY	0	0	2	1

Preamble: To familiarize the students with the different sophisticated instrumentations used in the laboratory and field for measuring/monitoring stress, strain, deflection etc. in structures. New construction materials, their testing and construction practices are introduced. It also provides the students to observe the behaviour of reinforced concrete structural elements and steel sections. It also encompasses to develop a firm foundation for research and practice in Civil Engineering.

General Instructions to Faculty:

1. Any 10 of the 13 experiments included in the list of experiments need to be performed mandatorily. Virtual Lab facility cannot be used to substitute the conduct of these mandatory experiments.

2. The laboratory should have possession of modern testing equipment such as Linear variable differential transducer -Hydraulic jack-load cells-indicators- crack detection microscope - Data logger-Rebound hammer, ultrasonic pulse velocity- rebar locator, core cutter, concrete penetrometer.

3. Periodic maintenance and calibration of various testing instruments needs to be made.

Course Outcomes:

After the completion of the course on Advanced Structural Engineering Lab, the student will be able to:

CO 1	Understand basic test for the materials,
CO 2	Compute the mix proportion for various types of concrete as per IS guidelines.
CO 3	Evaluate the mechanical properties of concrete
CO 4	Analyse the behaviour of reinforced concrete elements.
CO 5	Analyse the behaviour of steel members
CO 6	Familiarise modern instruments.

Mapping of course outcomes with program outcomes

	PO 1	PO 2	PO 3	PO 4	PO 5	PO 6	PO 7
CO 1	2	2	2	3	2	2	
CO 2	2	2	2	3	2	2	
CO 3	3	3	2	3	3	2	
CO 4	3	3	3	3	3	2	
CO 5	3	3	3	3	3	2	
CO 6	3	3	3	3	3	2	

Mark distribution

Total Marks	CIE	ESE	ESE Duration
100	100	–	–

Continuous Internal Evaluation Pattern:

The laboratory courses will be having only Continuous Internal Evaluation and carries 100 marks. Final assessment shall be done by two examiners; one examiner will be a senior faculty from the same department.

Syllabus and Course Plan**Mix design of concrete**

Material characterisation-Mix design of normal-fibre reinforced and self-compacting concrete as per IS code guidelines.

Study of instruments

Mechanical strain gauges-Electrical strain gauges - Linear variable differential transducer - Hydraulic jack-load cells-indicators-Data logger- crack detection microscope -Non-destructive testing

Testing of Reinforced concrete elements and Structural steel sections

Behaviour of under-reinforced concrete beams under flexure-shear- Behaviour of short reinforced concrete columns under axial compression-Steel bending tests on steel joists- Buckling of steel angles- Torsion of closed and open sections- Behaviour of bolted connections.

List of Experiments

Expt. No.	Title	Hours Allotted
1	Determination of properties of constituent materials in concrete.	2
2	Study on the mix design of normal and high strength concrete as per IS code. Introduction to fibre reinforced concrete.	2
3	Casting of cubes, beams and cylinders with designed normal strength concrete and fibre reinforced concrete.	2

4	Introduction to self-compacting concrete. Study on the mix design and flow properties of self-compacting concrete as per IS code.	2	CIVIL ENGINEERING -CE4
5	Study on the working of mechanical strain gauges-Electrical strain gauges - Linear variable differential transducer - Hydraulic jack-load cells-indicators- crack detection microscope -Data logger.		
6	Behaviour of under-reinforced concrete beams under flexure	2	
7	Behaviour of reinforced concrete beams under shear	2	
8	Bending tests on steel joists	2	
9	Behaviour of short reinforced concrete columns under axial compression	2	
10	Buckling of steel angles	2	
11	Torsion of closed and open sections	2	
12	Behaviour of bolted connections	2	
13	Non-destructive testing	2	

Reference Books/Resources:

1. Pillai S.U & Menon D – Reinforced Concrete Design, Tata McGraw Hill Book Co., 2009.
2. “Concrete Technology”- Neville – Pearson Publishers, 2000
3. Subramanian, N., “Design of Steel Structures”, Oxford University Press.
4. Iyengar, N.G.R., "Elastic Stability of Structural Elements", Macmillan India Ltd., New Delhi, 2007.
5. IS 456:2000, “PLAIN AND REINFORCED CONCRETE - CODE OF PRACTICE”, Bureau of Indian Standards New Delhi.
6. IS 10262 : 2019-Concrete Mix Proportioning-Guidelines.
7. IS 800:2007, “GENERAL CONSTRUCTION IN STEEL - CODE OF PRACTICE”, Bureau of Indian Standards New Delhi.
8. SP 6(1) Hand book for structural Engineers.
9. IS 4000 (1992): Code of practice for high strength bolts in steel structures [CED 7: Structural Engineering and structural section.

APJ ABDUL KALAM
TECHNOLOGICAL
UNIVERSITY

SEMESTER I

PROGRAM ELECTIVE I



CODE	COURSE NAME	CATEGORY	CIVIL	ENGIN	PERING	OF	CREDIT
221ECE036	ADVANCED THEORY AND DESIGN OF CONCRETE STRUCTURES	PROGRAMME ELECTIVE 1	3	0	0		3

Preamble: Design of an advanced reinforced concrete structures are one of the primary requisites of any structural engineer. Hence the course aims to provide a detailed theoretical background of various design philosophies and their applications using national and international design guidelines. Therefore, at the end of the course the student is expected to analyse and design various special reinforced concrete structures. The students are also able to apply the knowledge in real civil engineering problems and to design new and advanced reinforced concrete structures.

Course Outcomes: After the completion of the course on Advanced Theory and Design of Reinforced Concrete Structures, the student will be able to

CO 1	Understand the behaviour of reinforced concrete and its components.
CO 2	Familiarise the various advanced reinforced concrete structural elements.
CO 3	Analyse the various advanced reinforced concrete structural elements.
CO 4	Design the advanced reinforced concrete structural elements like deep beam, slender column.
CO 5	Design the special reinforced concrete structural elements like corbel and beam column joint.

Mapping of course outcomes with program outcomes

	PO 1	PO 2	PO 3	PO 4	PO 5	PO 6	PO 7
CO 1	1		2	3	2	1	1
CO 2	1		2	3	2	1	1
CO 3	3	2	3	3	3	2	1
CO 4	3	2	3	3	3	2	1
CO 5	3	2	3	3	3	2	1

Assessment Pattern

Bloom's Category	End Semester Examination
Remember	10
Understand	10
Apply	25
Analyse	15
Evaluate	–
Create	–

Mark Distribution

Total Marks	CIE	ESE	ESE Duration
100	40	60	2.5 hours

Continuous Internal Evaluation Pattern:

Preparing a review article based on peer reviewed original publications (minimum 10 publications shall be referred): 15 marks

Course based task/Seminar/Data collection and interpretation: 15 marks

Test paper, 1 no.: 10 marks

Test paper shall include minimum 80% of the syllabus.

End Semester Examination Pattern:

The end semester examination will be conducted by the respective College. There will be two parts; Part A and Part B. Part A will contain 5 numerical/short answer questions with 1 question from each module, having 5 marks for each question (such questions shall be useful in the testing of knowledge, skills, comprehension, application, analysis, synthesis, evaluation and understanding of the students). Students should answer all questions. Part B will contain 7 questions (such questions shall be useful in the testing of overall achievement and maturity of the students in a course, through long answer questions relating to theoretical/practical knowledge, derivations, problem solving and quantitative evaluation), with minimum one question from each module of which student should answer any five. Each question can carry 7 marks.

Note: The marks obtained for the ESE for an elective course shall not exceed 20% over the average ESE mark % for the core courses. ESE marks awarded to a student for each elective course shall be normalized accordingly. For example, if the average end semester mark % for a core course is 40, then the maximum eligible mark % for an elective course is $40+20 = 60$ %.

PART A

(Answer ALL questions; each question carries 5 marks)

1. (a) Write short notes on
 - i) Confined concrete
 - ii) Bauschinger effect
2. Draw the design bending moment envelop allowing 30% redistribution for the beam fixed at both ends of span 8m and carrying a udl of 25kN/m.
3. Sketch the strut and tie model for a corbel and describe how the load is carried by corbel.
4. What is the purpose of shear wall? Discuss the classification of shear walls.
5. Explain with a sketch the forces acting on a beam column joint.

PART B

(Answer any FIVE questions; each question carries 7 marks)

6. Determine the short-term deflection of a simply supported beam having a span of 6m and a cross section of 300x600mm. It is subjected to a udl of 30kN/m. The tension reinforcement consists of three 25 mm dia bars and compression reinforcement as two 20mm dia. Bars both at an effective cover of 40 mm. The grade of concrete is M25 and steel used is Fe415.
7. A beam of size 250mmx600mm with 25mm clear cover to steel is reinforced with 3x25mm dia. as tension steel and 3x16mm dia. as compression steel. The section is subjected to a maximum bending moment of 220kN-m. Use M20 and Fe415. Determine the maximum probable crack width at the soffit of the beam.
8. A transfer girder carries two square column of size 600mm each with factored load 7500kN located at 1/3rd of the span. The beam has thickness 600mm and total depth 4m. Use $f_{ck} = 35\text{N/mm}^2$ and $f_y = 415\text{N/mm}^2$. The girder has a span of 12m. Design the beam for given loads ignoring self-weight Use Strut and Tie.
9. A column of size 400 mm x 600 mm subjected to factored load $P_u = 2000$ kN, $M_{ux} = 160$ kNm and $M_{uy} = 120$ kNm. The unsupported length of column is 4m. Design the reinforcements in the column, assuming M20 concrete and Fe415 steel. Provide 60mm effective cover to reinforcement
10. Design an exterior Type I joint for the following data:

Column 500 x 500mm with 8 Nos. 25mm longitudinal bars, maximum load on column is 5000 kN.

Main beam 450 x 500 mm with ultimate capacity 390 kNm and tension steel 4 Nos. 25mm.

Spandrel beam cross section 450 x 600 mm, Storey height 3 m.

Assume M20 concrete and Fe 415 steel.
11. How the beam column joints are classified into different categories? Explain with neat sketch each one of them.
12. Explain classical theory of cracking. What are the factors affecting the crack width?

Syllabus

Module 1

Stress-strain characteristics of concrete under single and multi-axial stresses- confined concrete--Effect of cyclic loading on concrete and reinforcing steel- Ultimate Deformation and ductility of members with flexure strength and deformation of members under shear-- Moment-curvature relationship of RCC flexural members- Tension stiffening effect of concrete in flexural members, and corresponding equivalent moment of inertia-Codal procedures on immediate and long-term deflections in reinforced concrete beam and slab as per IS.

Module 2

Classical theory of cracking-factors affecting crack width-control of cracking- Codal procedures on crack width computation in reinforced concrete beams in flexure as per IS- Inelastic behaviour of reinforced concrete beams – plastic hinge formation-length of plastic hinge-Conditions for moment redistribution-redistribution of moment in reinforced concrete fixed and two span continuous beams (numerical problems).

Module 3

Development- Design methodology- selecting dimensions for struts, tie and nodal zones-compression fans- ACI 318 Provisions- Design of deep beam as per ACI 318 provisions- Design of Corbel as per ACI 318 provisions.

Module 4

Biaxial bending of columns- interaction diagrams-IS method of design-Analysis and Design of slender RCC columns- Types of shear walls-Loads in shear walls-Principle of shear wall analysis-Distribution of lateral loads in uncoupled shear walls- Equivalent Stiffness Method-Shear Wall Frame Interactions.

Module 5

Beam column joint- classification –Type 1 and Type 2 joint- failures in joint-forces acting on joint- Ductile detailing as per IS code- joint shear strength as per ACI 318 code (numerical problem is not required)- Design of an exterior type I beam-column joint.

Course Plan

No	Topic	No. of Lectures
1	Introduction to behaviour of reinforced concrete structural elements and Limit state of Deflection (9)	
1.1	Stress-strain characteristics of concrete under single and multi-axial stresses- confined concrete--Effect of cyclic loading on concrete and reinforcing steel	3
1.2	Ultimate Deformation and ductility of members with flexure	2

	strength and deformation of members under shear--Moment-curvature relationship of RCC flexural members.	CIVIL ENGINEERING-CE 4
1.3	Tension stiffening effect of concrete in flexural members, and corresponding equivalent moment of inertia	1
1.4	Codal procedures on immediate and long-term deflections in reinforced concrete beam as per IS	2
1.5	Codal procedures on immediate and long-term deflections in reinforced concrete slab as per IS.	1
2	Limit state of cracking and redistribution of moments. (7)	
2.1	Classical theory of cracking-factors affecting crack width-control of cracking	2
2.2	Codal procedures on crack width computation in reinforced concrete beams in flexure as per IS	2
2.3	Inelastic behaviour of reinforced concrete beams – plastic hinge formation-length of plastic hinge.	1
2.4	Conditions for moment redistribution-redistribution of moment in reinforced concrete fixed and two span continuous beams (numerical problems)	2
3	Strut and Tie Models (8)	
3.1	Development- Design methodology- selecting dimensions for struts, tie and nodal zones-compression fans	2
3.2	ACI 318 Provisions	1
3.3	Design of deep beam as per ACI 318 provisions	2
3.4	Design of Corbel as per ACI 318 provisions	3
4	Slender Columns and Shear wall (9)	
4.1	Biaxial bending of columns- interaction diagrams	2
4.2	IS method of design-Analysis and Design of slender RCC columns.	2
4.3	Types of shear walls-Loads in shear walls-Principle of shear wall analysis- Distribution of lateral loads in uncoupled shear walls	3
4.4	Equivalent Stiffness Method- Shear Wall Frame Interactions.	2
5	Beam-column joint (7)	
5.1	Beam column joint- classification –Type 1 and Type 2 joint-failures in joint-forces acting on joint.	3
5.2	Ductile detailing as per IS code- joint shear strength as per ACI 318 code (numerical problem is not required)	2
5.3	Design of an exterior type I beam-column joint	2

1. Varghese P.C, Advanced Reinforced Concrete Design, Prentice Hall of India Pvt Ltd, 2008.
2. Park,R and Paulay T, “Reinforced Concrete Structures”, (John Wiley & Sons, New York).
3. Arthur. H. Nilson, David Darwin and Charles W Dolan, “Design of Concrete Structures”, Tata McGraw Hill, 2004
4. Pillai S.U & Menon D – Reinforced Concrete Design, Tata McGraw Hill Book Co., 2009.
5. Purushothaman.P. “Reinforced Concrete Structural Elements”, Behaviour , Analysis and Design (Tata McGraw Hill 1986)
6. Relevant IS codes (IS 456, IS 13920)
7. ACI 318-11, Building Code Requirements for Structural Concrete and Commentary, ACI Michigan.

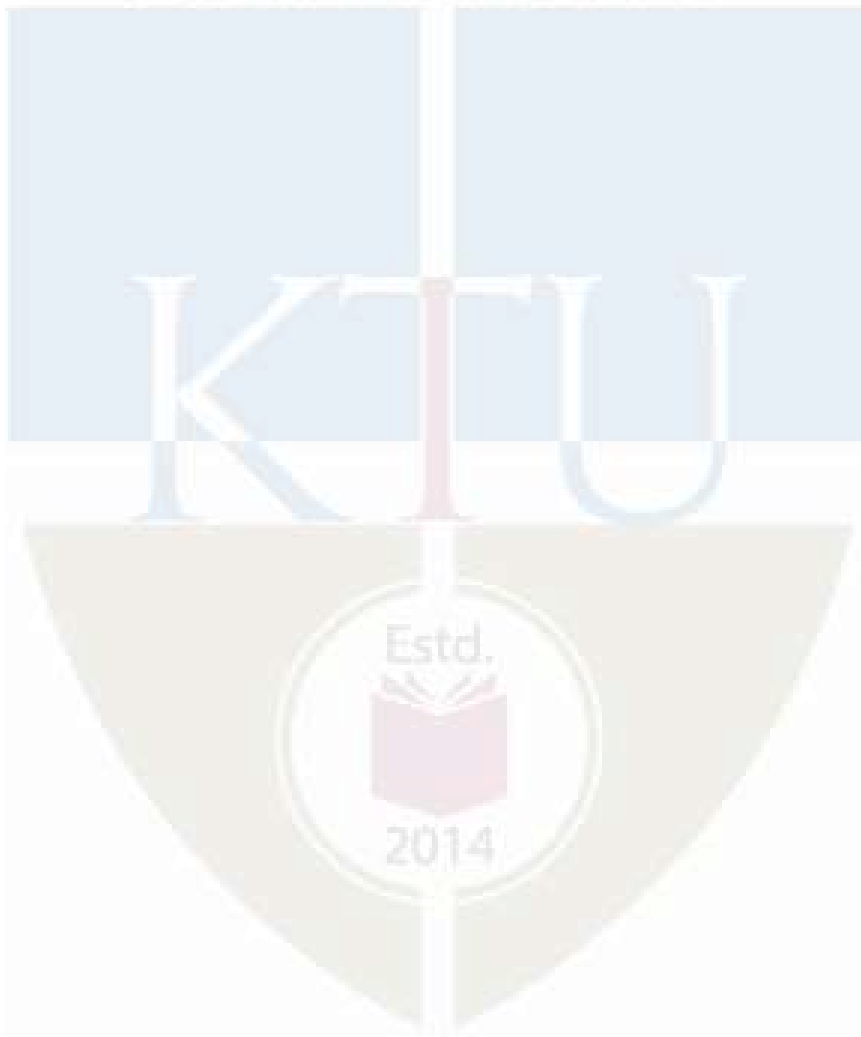

CODE	COURSE NAME	CATEGORY	L	T	P	CREDIT
221ECE037	HIGH RISE BUILDINGS	PROGRAM ELECTIVE 1	3	0	0	3

Preamble: Due to urbanization and lack of land, it has become inevitable to construct high rise structures. This subject will make the students aware of the various structural systems for high rise structures and the suitability of each towards different varying parameters. The course provides the basic principles involved in the design of high-rise structures. Different types of loads acting on a high-rise building are to be discussed after which the structural system required to take these loads are to be dealt with. The methods of analysis of high-rise structure are also to be discussed.

Course Outcomes: After the completion of the course on High-Rise Structures the student will be able to

CO 1	Describe the design philosophy and design criteria for tall buildings.
CO 2	Identify the characteristics of wind and earthquake loads acting on high rise structure.
CO 3	Choose and apply appropriate structural systems for different sizes and heights of structures
CO 4	Analyse the effect of gravity and lateral loads on structural members of tall structures.
CO 5	Analyse the behaviour of different structural forms and systems to carry lateral loads of high-rise structures
CO 6	Apply modelling and analysis methods for high rise buildings.

Mapping of course outcomes with program outcomes

	PO 1	PO 2	PO 3	PO 4	PO 5	PO 6	PO 7
CO 1			2				
CO 2	1		2				
CO 3	1		3	2	1		
CO 4	1		2				
CO 5	1		2				
CO 6	2		3		1		

(1-Weak, 2-Medium, 3- strong)

Assessment Pattern

Bloom's Category	End Semester Examination
Apply	30
Analyse	10
Evaluate	10
Create	10

Mark distribution

CIVIL ENGINEERING-CE4

Total Marks	CIE	ESE	ESE Duration
100	40	60	2.5 hours

Continuous Internal Evaluation Pattern: 40 marks

Preparing a review article based on peer reviewed original publications (Minimum 10 publications shall be referred): 15 marks

Course based task/Seminar/Data collection and interpretation : 15 marks

Test paper, 1 no. : 10 marks

Test paper shall include minimum 80% of the syllabus.

End Semester Examination Pattern: 60 marks

The end semester examination will be conducted by the respective College. There will be two parts; Part A and Part B. Part A will contain 5 numerical/short answer questions with 1 question from each module, having 5 marks for each question (such questions shall be useful in the testing of knowledge, skills, comprehension, application, analysis, synthesis, evaluation and understanding of the students). Students should answer all questions. Part B will contain 7 questions (such questions shall be useful in the testing of overall achievement and maturity of the students in a course, through long answer questions relating to theoretical/practical knowledge, derivations, problem solving and quantitative evaluation), with minimum one question from each module of which student should answer any five. Each question can carry 7 marks.



QP CODE:

Reg No.: _____

Name: _____

**APJ ABDUL KALAM TECHNOLOGICAL UNIVERSITY FIRST SEMESTER
M.TECH. DEGREE EXAMINATION, MONTH & YEAR**

Course Code: 221ECE037

HIGH-RISE BUILDINGS

Max. Marks: 60

Duration: 2.5 hours

PART A

(Answer ALL questions; each question carries 5 marks)

1. Explain the factors affecting the growth, height and structural forms of tall buildings.
2. Discuss the different types of gravity loads and associated parameters to be considered for the analysis and design of a tall building.
3. List with sketches, three floor systems suitable for high rise structures.
4. Explain the behaviour of high-rise structures with braced frames.
5. Discuss the advantages of outrigger braced structure over core structure.

PART B

(Answer any FIVE questions; each question carries 7 marks)

6. Discuss the design criteria for high rise structures.
7. Explain the need of wind tunnel test. What are the different types of wind tunnel experiments for high rise buildings.
8. Explain the different performance levels of building considered in Performance based seismic design.
9. A three-span beam each of 4m span carries a dead load of 6 kN/m for all the spans and 4kN/m for the two consecutive spans from right. Determine the support moments for the beams, if it is simply supported through out.
10. Discuss the advantage of a wall frame structure over framed or wall structures.
11. Discuss the different types of modelling for high rise structures.

No	Topic	No. of Lectures
Module – 1		
1.1	Definition and need of tall building - Historic background - factors affecting growth	1
1.2	Design Criteria, Design Philosophy of High-Rise structures	2
1.3	Materials	2
2.1	Dead and live load, live load reduction techniques	2
Module – 2		
2.2	Sequential loading, Impact loading	1
2.3	Wind Loading - Wind Characteristics, Static and Dynamic wind effects - Analytical and wind tunnel experimental method	3
2.4	Seismic Loading - Earthquake loading-equivalent lateral force method, modal analysis, Introduction to Performance based seismic design	3
Module – 3		
3.1	Structural form, Floor systems, Rigid frame Structures, rigid frame behaviour	3
3.2	Approximate determination of member forces by gravity loading-two cycle moment distribution	3
3.3	Approximate determination of member forces by lateral loading-Portal method, Cantilever method	2
Module – 4		
4.1	Braced frames- Types of bracings-behaviour of bracings, behaviour of braced bents-method of member force analysis-method of drift analysis	2
4.2	Infilled frames, behaviour of infilled frames-stresses in infill-forces in frame- design of infill and frame (no numerical)-horizontal deflection	2
4.3	Shear wall Structures-behaviour of shear wall structures - proportionate wall systems, non-proportionate wall systems (no analysis required)- horizontal deflection, Coupled shear walls - behaviour of coupled wall structures	2
4.4	Wall frame structures- behaviour of wall frames	2
Module – 5		
5.1	Tubular structures-framed tube structures-bundled tube structures-braced tube structures	1
5.2	Core structures, Outrigger-Braced Structures	1
5.3	Foundations for tall structures-pile foundation-mat foundation	2
5.4	Modelling for analysis for high rise structures – approximate analysis, accurate analysis and reduction technique.	2

5.5	Discussion of various Finite Element Packages for the analysis of High-Rise Structures	CIVIL ENG NEERING-CE4
-----	--	-----------------------

Text Books

1. Bryan Stafford Smith and Alex Coull, Tall Building structures: Analysis and Design, Wiley-Interscience, New York, 1991.
2. Bungale S Taranath, Structural Analysis and Design of Tall Buildings, Tata McGraw Hill, 1988.

Reference Books

1. Robert L Wiegel, Earthquake Engineering. Prentice Hall, 1970.
2. Kolousek V, Pimer M, Fischer O and Naprstek J, Wind effects on Civil Engineering Structures. Elsevier Publications, 1984
3. IS 16700:2017, Criteria for Structural Safety for Tall Concrete Buildings, BIS
4. High Rise Building Structures, Wolfgang Schueller, Wiley
5. Designing and installation of services in building complexes and high rise buildings, Jain, V.K., Khanna Publishers, New Delhi.
6. High rise structures; design and constructions practices for middle level cities, Gupta, Y.P., New Age International Publishers, New Delhi.

CODE	COURSE NAME	CATEGORY	L	T	P	CREDIT
221ECE038	EXPERIMENTAL METHODS IN STRUCTURAL ENGINEERING	PROGRAM ELECTIVE 1	3	0	0	3

Preamble: The proposed course is expected to enhance and strengthen the knowledge on conducting laboratory experiments on structures. Purpose and structure of measurement system, strain gauge types, LVDT, photo elasticity, Nondestructive testing methods, Computer based data acquisition systems, Errors in measurement will be discussed.

Course Outcomes: After the completion of the course the student will be able to

CO 1	Understand characteristics of a measurement system
CO 2	Understand working and types of strain gauges and force transducers
CO 3	Understand working and types of potentiometers and accelerometers
CO 4	Understand different types of Non destructive testing methods
CO 5	Understand the application of Two-dimensional photoelasticity in analysing stress or strain.
CO 6	Understand working of recording instruments like chart recorders and CROs.

Mapping of course outcomes with program outcomes

	PO 1	PO 2	PO 3	PO 4	PO 5	PO 6	PO 7
CO 1	1	2	3	2	2	1	1
CO 2	1	2	3	2	2	1	1
CO 3	1	2	3	2	2	1	1
CO 4	1	2	3	2	2	1	1
CO 5	1	2	3	2	2	1	1
CO 6	1	2	3	2	2	1	3

Assessment Pattern

Bloom's Category	End Semester Examination
Apply	25%
Analyse	25%
Evaluate	20%
Create	30%

Total Marks	CIE	ESE	ESE Duration
100	40	60	2.5 hours

Continuous Internal Evaluation Pattern:**Continuous Internal Evaluation: 40 marks**

Preparing a review article based on peer reviewed original publications (minimum 10 publications shall be referred): 15 marks

Course based task/Seminar/Data collection and interpretation: 15 marks

Test paper 1 no.: 10 marks

Test paper shall include minimum 80% of the syllabus.

End Semester Examination Pattern:

The end semester examination will be conducted by the respective College. There will be two parts; Part A and Part B. Part A will contain 5 numerical/short answer questions with 1 question from each module, having 5 marks for each question (such questions shall be useful in the testing of knowledge, skills, comprehension, application, analysis, synthesis, evaluation and understanding of the students). Students should answer all questions. Part B will contain 7 questions (such questions shall be useful in the testing of overall achievement and maturity of the students in a course, through long answer questions relating to theoretical/practical knowledge, derivations, problem solving and quantitative evaluation), with minimum one question from each module of which student should answer any five. Each question can carry 7 marks.

Note: The marks obtained for the ESE for an elective course shall not exceed 20% over the average ESE mark % for the core courses. ESE marks awarded to a student for each elective course shall be normalized accordingly. For example, if the average end semester mark % for a core course is 40, then the maximum eligible mark % for an elective course is $40+20 = 60$ %

Reg. No.....

Name:.....

**APJ ABDUL KALAM TECHNOLOGICAL UNIVERSITY
FIRST SEMESTER M.TECH DEGREE EXAMINATION**

STRUCTURAL ENGINEERING

221ECE038: EXPERIMENTAL METHODS IN STRUCTURAL ENGINEERING

Max. Marks: 60

Duration: 3 Hours

PART A

Answer all questions. Each question carries 5 marks (5x 5=25Marks)

1. Explain measurement system and its structure with a diagram.
2. Explain terms: Repeatability, Sensitivity and Precision
3. Explain ideal characteristics of a strain gauge.
4. Explain strain gauge construction.
5. Explain the types of potentiometers.

PART B

Answer any five questions (5x7=35Marks)

6. Explain any seven static performance characteristics of a measurement system.
7. Explain electrical resistance strain gauges- it's working with figure, advantages and disadvantages.
8. Explain Vibrating wire resistance strain gauges- it's working with figure, advantages and disadvantages.
9. Explain Piezo electric accelerometers - it's working with figure, advantages and disadvantages.
10. Explain the principle, working, advantages and disadvantages of LVDT with a figure.
11. Explain principle, working, correlation with quality of concrete, advantages and disadvantages of Rebound hammer method with a figure.
12. Explain principle, components and working of Cathode ray oscilloscope with a figure.

.....

No	Topic	No. of Lectures
1	Measurement system	
1.1	measurement system – structure , purpose, components	1
1.2	Static Characteristics - Accuracy, Precision, Repeatability / Reproducibility , Threshold,	1
1.3	Static Characteristics - Resolution, Sensitivity, Discrimination, Static error ,Tolerance	1
1.4	Static Characteristics - Span, Range, Dead space, Hysteresis, Drift, Linearity	1
1.5	Dynamic Characteristics – Fidelity, Dynamic error, speed of response, measuring lag.	1
1.6	zero order, first order and second order instruments, Calibration – Standards and evaluation	1
2	Measurement of Strain and Force transducers	
2.1	Strain gauge – Ideal characteristics – Types: Mechanical, Electrical resistance, Optical gauges;	1
2.2	Electrical resistance strain gauges: working and types.	1
2.3	Gauge materials: foils, backing, adhesives. Gauge construction – gauge factor;	1
2.4	Vibrating wire strain gauges- working.	1
2.5	Strain gauge bridges – Potentiometric and Wheatstone bridge – strain sensitivity; forms of wheat stone bridge.	1
2.6	Strain gauge Rosette – two elements, three elements – rectangular, star- delta.	1
2.7	Force transducers: working principle – Load cells: different types.	1
2.8	Pressure transducer: working- types.	1
3	Measurement of displacement and acceleration	
3.1	Potentiometers – principle, working, different types- linear, rotary;	1
3.2	Linear variable differential transformer – principle, working, advantages	1
3.3	Accelerometers – Application- Characteristics of Accelerometers	1
3.4	Working of Piezo electric and Piezo resistive accelerometer	1
3.5	Working of Capacitive accelerometer	1

3.6	Working of LVDT Type accelerometer	CIVIL ENGINEERING-CE4
3.7	Working of potentiometric accelerometer	1
3.8	Calibration techniques.	1
4	Non Destructive Testing Methods and Statistical Analysis	
4.1	uses- advantages and disadvantages of NDT methods –	1
4.2	Ultrasonic pulse velocity Method- principle, working, advantages and disadvantages, correlation of each method with quality of concrete:	1
4.3	Hardness methods - Rebound Hammer - principle, working, advantages and disadvantages, correlation of each method with quality of concrete	1
4.4	Core sampling technique- principle, working, advantages and disadvantages, correlation of each method with quality of concrete	1
4.5	Pullout experiment - principle, working, advantages and disadvantages	1
4.6	Detection of embedded reinforcement – acoustic emission and electromagnetic method- principle, advantages, Limitations, application.	2
4.7	- Errors in measurement: Systematic and Random;	1
4.8	Uncertainties in measurement- Types; Normal Distribution	1
4.9	Confidence level- determination.	1
5	Photo elasticity and Indicating & recording elements	
5.1	uses of polarised light - Maxwell's stress optic law – Two-dimensional photo elasticity.	1
5.2	polariscopes – use, components, working and Types.	1
5.3	Photo elastic model materials- properties; Isoclinics and Isochromatics – properties.	1
5.4	Moire fringe method of stress or strain analysis- techniques and its use. Advantages and disadvantages of Moire fringe method.	2
5.5	Chart recorders – Types, working.	1
5.6	Cathode ray oscilloscope – principle, components, working.	1
5.7	Computer based data acquisition systems – structure and	1

Reference Books

1. Bently JP - Principles of Measurement Systems – Longman, 1995
2. Nakra B. C. & Chaudhry - Instrumentation Measurement & Analysis - Tata McCraw Hill, 2004
3. Adams L F - Engineering Measurements and Instrumentation – English University Press, 1975
4. Doebelin E O - Measurement Systems Application & Design - McGraw Hill, 2003
5. Dally JW & Riley WF – Experimental stress Analysis - McGraw Hill, 1991

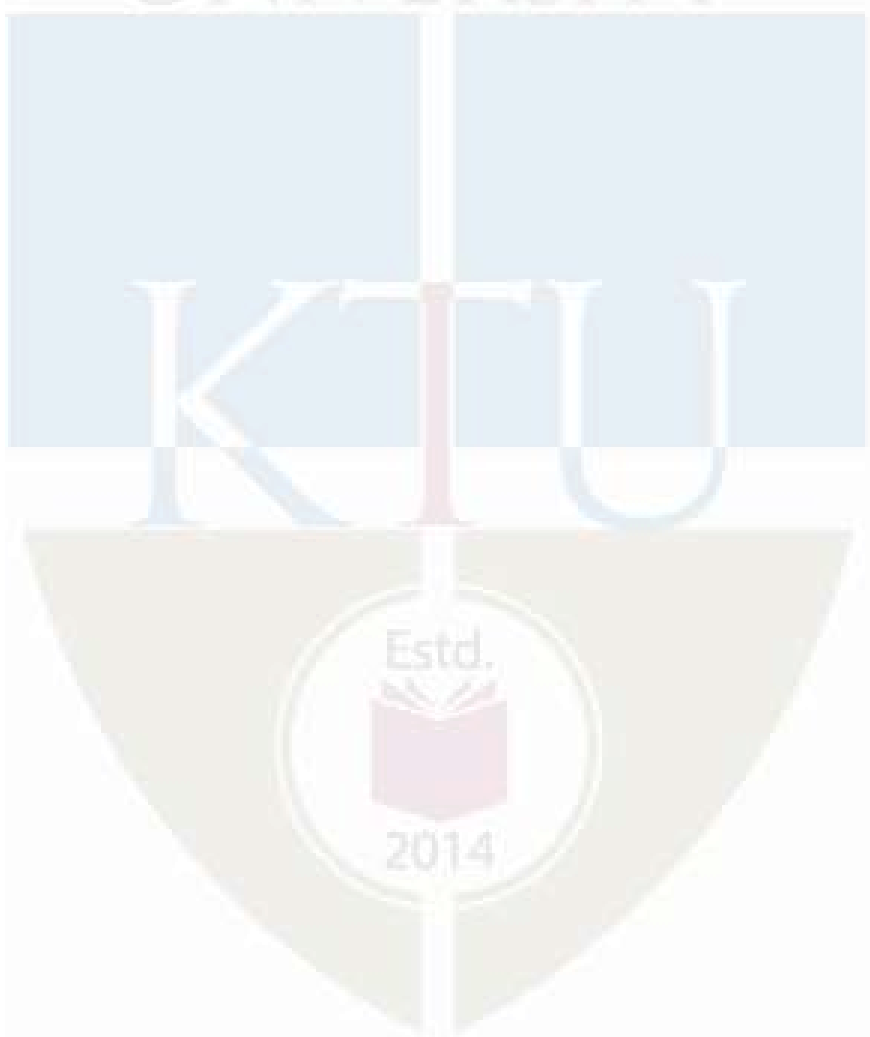

CODE	COURSE NAME	CATEGORY	CIVIL	EN	G	ENGINEERING	CREDITS
221ECE039	STRUCTURAL OPTIMIZATION AND RELIABILITY OF STRUCTURES	PROGRAM ELECTIVE 1	3	0	0		3

Preamble: Uncertainty is inherent in the design of structural systems, whether it be on the loading front or be on the material strength front or even on the analysis model. Optimization and Reliability techniques help engineers arrive at an optimal design solution for engineering structures in an uncertain environment. This course is designed to introduce structural optimization and structural reliability methods to graduate students. The course, through first two modules introduces conventional techniques as well as genetic algorithm methods for structural optimization application. Modules III & IV covers the elementary probability theory, random variables and univariate and bivariate distributions. Level 2 reliability methods and simulation techniques are introduced in Module V.

Course Outcomes: After the completion of the course the student will be able to

CO 1	Formulate optimization problems in structural engineering
CO 2	Apply appropriate algorithms for the solution of optimization problems in structural engineering
CO 3	Identify the various sources of uncertainty in variables encountered in structural design / assessment and apply the mathematical theory of probability for modelling uncertainties encountered in engineering systems.
CO 4	Evaluate the probability of failure / reliability of structural elements and simple structural components using level 2 reliability methods as well as simulation techniques.

Mapping of course outcomes with program outcomes

	PO 1	PO 2	PO 3	PO 4	PO 5	PO 6	PO 7
CO 1	3	1	3	3	3	2	3
CO 2	3	1	3	3	3	2	3
CO 3	3	1	3	3	3	2	3
CO 4	3	1	3	3	3	2	3

Assessment Pattern

Bloom's Category	Continuous Assessment Test	End Semester Examination
Understand		10
Apply		25
Analyse		15
Evaluate		10
Create		-

Mark distribution

CIVIL ENGINEERING-CE4

Total Marks	CIE	ESE	ESE Duration
100	40	60	2.5 hours

Continuous Internal Evaluation Pattern:

Preparing a review article based on peer reviewed original publications (minimum 10 publications shall be referred): 15 marks

Course based task/Seminar/Data collection and interpretation: 15 marks

Test paper, 1 no.: 10 marks

Test paper shall include minimum 70% of the syllabus.

End Semester Examination Pattern:

The end semester examination will be conducted by the respective College. There will be two parts; Part A and Part B.

Part A will contain 5 numerical/short answer questions with 1 question from each module, having 5 marks for each question (such questions shall be useful in the testing of knowledge, skills, comprehension, application, analysis, synthesis, evaluation and understanding of the students). Students should answer all questions.

Part B will contain 7 questions (such questions shall be useful in the testing of overall achievement and maturity of the students in a course, through long answer questions relating to theoretical/practical knowledge, derivations, problem solving and quantitative evaluation), with minimum one question from each module of which student should answer any five. Each question can carry 7 marks.



PART A**Answer all questions.****All Questions carry equal (5) marks**

1. A contractor is considering two general pits from which he may purchase materials to supply for a project. The unit cost to load and deliver the material to project site is Rs 500/m³ from pit 1 and Rs 300/m³ from pit 2. He must deliver a minimum of 10,000 m³ to the site. The mix that he delivers must consist of at least 50% sand, not more than 60% gravel, not more than 8% silt. The material at pit 1 consists of 30% sand and 70 % gravel. The material at pit 2 consists of 60% sand, 30% gravel and 10% silt. Formulate a minimum cost model.
2. Explain the solution procedure of an unconstrained Geometric programming problem using differential calculus. Illustration should be based on the standard form of a geometric programming problem.
3. A building may fail by excessive settlement of the foundation or by collapse of the superstructure. Over the life of the building, the probability of excessive settlement of the foundation is estimated to be 0.10, whereas the probability of collapse of the superstructure is 0.05. Also, if there is excessive settlement of the foundation, the probability of superstructure collapse will be increased to 0.20.
 - (a) What is the probability that building failure will occur over its life ?.
 - (b) If the building failure should occur during its life, what is the probability that the failure is due to superstructure collapse?
4. If X is maximum annual wind speed with the probability density function

$$f_X(x) = \lambda \cdot e^{-\lambda x}; x \geq 0$$

Where, λ is the parameter of the distribution. The wind record shows that the probability of the maximum annual wind velocity less than 70 mph is 0.9. Determine the parameter λ . Also determine the mean, standard deviation.

5. The axial load carrying capacity of a column R , is normally distributed with $\mu_R = 1000kN$ and $\delta_R = 0.2$. The column is subjected to an axial load S , which is normally distributed with $\mu_S = 700kN$ and $\delta_S = 0.43$. Calculate the probability of failure of the column assuming R and S to be independent.

PART B**Answer any FIVE questions**

6. Find the ultimate plastic moment capacities M_b and M_c of the steel frame ABCD for minimum weight. The weight of the frame may be assumed to vary linearly with the plastic moment capacity. Column AB and CD are identical. AB=CD=4m, BC=6m. At midspan of beam BC, 140 KN load acts downwards. A lateral load of 70 KN load acts at joint B towards right. Assume supports A and D as fixed.

$$\text{Minimize } z = \frac{1}{x_1 x_2 x_3} + 2x_2 x_3 + 3x_1 x_3 + 4x_1 x_2$$

Subject to the condition that all variables have positive values.

8. The problem of finding the equilibrium configuration of a two bar pendulum subjected to horizontal force is coined as an optimization problem involving minimization of potential energy. The problem is proposed to be solved using Genetic Algorithm. The inclinations of the bars to the vertical (α_1 and α_2) are treated as the decision variables. The integer values assigned to the different possible angles are listed in table 1.

TABLE 1

Sl.no:	Angle	Integer	Sl. no:	Angle	Integer
1	0	0	9	48	8
2	6	1	10	54	9
3	12	2	11	60	10
4	18	3	12	66	11
5	24	4	13	72	12
6	30	5	14	78	13
7	36	6	15	84	14
8	42	7	16	90	15

An initial population of variables (α_1 and α_2) was randomly generated as given in table 2. Tabulate its binary encoding (8 bit string with 2 substrings of 4 bit each representing each variable). The fitness of the individual strings are also given in table 2. Calculate the expected count. Based on the expected count, judiciously create a mating pool after reproduction.

TABLE 2

Population No:	Angles		Fitness
	α_1	α_2	
1	0	0	1
2	12	18	1.8
3	84	72	1.92
4	36	60	4.58
5	6	30	3.01
6	42	72	4.6
7	84	60	1.92
8	12	6	2.11

9. a. Write a note on the common probability distributions used in modelling uncertainties in the context of structural reliability analysis. (3 marks)

b. A bridge can be damaged by failure in foundation (F) or in the superstructure (S). The corresponding failure probabilities for a particular bridge are estimated to be 0.05 and 0.01 respectively. Also, if there is a foundation failure, then the probability that the superstructure will also suffer some damage is 0.50.

(i) find the probability of damage to the bridge

(ii) If the events F and S are statistically independent, what is the probability of damage to the bridge. (4 marks)

10. a. What are joint probability distributions? Develop expressions for absolute and central moments related to continuous joint distributions. (3 marks)

b. Given $f_{XY}(x, y) = A \cdot x$; for $0 \leq y \leq x \leq 1.0$.

find (i) the constant A, (ii) the marginal density functions $f_X(x)$ and $f_Y(y)$ and

(iii) The conditional densities $f_{X|Y}(x|y)$ and $f_{Y|X}(y|x)$ (4 marks)

11. a. Derive the exact solution for the probability of failure when the demand and capacity variables (R and S) and uncorrelated and lognormally distributed. (3 marks)

b. The buckling strength of a column is given by

$$R = \frac{\pi^2 EI}{l^2}$$

Where, E is the Young's modulus, I the moment of Inertia and l the length of the column.

The column is subjected to a load Q . The mean and coefficient of variations of all the random variables are given below.

$$\mu_E = 2.03 \times 10^5 \text{ N/mm}^2; \delta_E = 0.1; \mu_I = 12.5 \times 10^6 \text{ mm}^4; \delta_I = 0.05$$

$$\mu_l = 5000 \text{ mm}; \delta_l = 0.05; \mu_Q = 700 \text{ kN}; \delta_Q = 0.3$$

If all the variables are lognormally distributed and uncorrelated, define a suitable performance function and hence determine the probability of failure of the column.

12. a. Explain the procedure for generation of samples of a random variable following an arbitrary distribution. (2 marks)

b. Estimate the Hasofer-Lind reliability index corresponding to shear mode of failure a simply supported steel I beam. The beam is subjected to a point load Q at midspan. The following statistics are known about the load and resistance variables.

$$\mu_Q = 4000 \text{ N}; \sigma_Q = 1000 \text{ N}; \mu_F = 95 \text{ MPa}; \sigma_F = 10 \text{ MPa}$$

$$\mu_D = 50 \text{ mm}; \sigma_D = 2.5 \text{ mm}$$

Web thickness, $t_w = 1.25 \text{ mm}$ (deterministic)

Where D is the overall depth of beam and F is the shear strength of material. Q , F and D are uncorrelated normal random variables.

NB: Two cycles of iterations alone expected.

(5 marks)

Syllabus and Course Plan

(For 3 credit courses, the content can be for 40 hrs and for 2 credit courses, the content can be for 26 hrs. The audit course in third semester can have content for 30 hours).

No	Topic	No. of Lectures
1	Module 1	
1.1	Engineering application of Optimization- statement of an optimization problem-Design vector, design constraints, objective function-classification of optimization problems.	1 Hr.
1.2	Classification of optimization problem based on nature of objective function- linear and nonlinear programming problems-standard form of linear programming problems.	1 Hr.
1.3	Simplex algorithm-identifying an optimal point	1 Hr.
1.4	Duality in linear programming, symmetric primal-dual relation.	1 Hr.
1.5	Primal dual relation when the primal is in standard form-degeneracy	1 Hr.
1.6	Application of linear programming in Civil Engineering	1 Hr.
1.7	Linear programming problem examples on design of tubular column	1 Hr.
1.8	Limit design of steel portal frames-graphical method of solution	1 Hr.
2	Module II	
2.1	Dynamic programming-multistage decision process-conversion of a numerical system in to a serial system	1 Hr.
2.2	Concept of sub optimization and the principle of optimality	1 Hr.
2.3	Computational procedure in dynamic programming	1 Hr.
2.4	Unconstrained minimization problem-solution of an unconstrained geometric programming problem using differential calculus	1 Hr.
2.5	History and development of genetic algorithm-basic concepts-biological background	1 Hr.
2.6	Genetic modelling-Representation of design variables, objective function and constraints. Creation of off springs-search space-binary encoding-fitness function	1 Hr.
2.7	Genetic operators-reproduction-roulette wheel selection-cross over-mutation	1 Hr.
2.8	Convergence of genetic algorithm. Comparison of Genetic algorithm with other metaheuristic approaches	1 Hr.
2.9	Solution of constrained optimization problems using genetic	1 Hr.

	algorithm	CIVIL ENGINEERING-CE4
	Numerical example using genetic algorithm	1 Hr.
3	Module III	
3.1	Uncertainties in engineering design- sources; Need for reliability analysis; Review of fundamental theory of probability - events & associated probability; Combination of events; De Morgan's rule; Axioms of probability, conditional probability, statistical independence and total probability theorem Note: examples related to structural engineering for illustration to be given as hand out and discussion on the solved example.	1 Hr.
3.2	Random events and random variables- Probability structure of discrete & continuous random variables	1 Hr.
3.3	Main descriptors of random variables; Moments of random variables	1Hr.
3.4	Common continuous probability distributions (Continuous & Discrete) - Binomial, Poisson, Exponential, Gamma, Uniform, Normal and lognormal distributions- Note: examples related to structural engineering for illustration to be given as hand out and discussion on the solved example.	2Hr.
4	Module IV	
4.1	Joint probability distributions– Discrete random variables (bivariate case) – Marginals and conditional distributions - illustrative examples from structural engineering.	1 Hr
4.2	Joint probability distributions– Continuous random variables (bivariate case) Marginal and conditional distributions- illustrative examples from structural engineering.	1 Hr
4.3	Correlation and correlation coefficients - discrete and continuous RV case	1 Hr.
4.4	Functions of random variables- one linear function of multiple random variables – second moment statistics - illustrative examples from structural engineering.	2 Hr
4.5	Nonlinear function of multiple random variables- second moment statistics - illustrative examples from structural engineering.	1 Hr
5	Module V	
5.1	Basics of structural reliability- concept of limit states/ performance functions; Space of state variables.	1 Hr.
5.2	Probability failure for performance function involving normally distributed random variables and lognormally distributed random variables.	1 Hr.
5.3	Definition of reliability in standard Normal space (Cornell's reliability index).	1 Hr.
5.4	FORM for linear performance functions.	1 Hr.
5.5	MVFOSS for non-linear performance functions.	1 Hr.
5.6	Hasofer-Lind's definition of reliability.	1 Hr.
5.7	Rackwitz-Feissler algorithm.	1 Hr.

5.8	Second order reliability methods.	CIVIL ENGINEERING-CE4
5.9	Simulation based reliability estimation-Monte-Carlo Methods- simulation of random numbers with arbitrary distributions – estimation of failure probability.	2 Hrs

Reference Books

1. Singiresu S. Rao, “Engineering Optimization (Theory and Practice)” 3rd Edition, New Age International (P) Ltd.
2. Kirsch U., “Optimum Structural Design”, McGraw Hill
3. Fox R.L., “Optimization Methods for Engineering Design”, Addison Wesley
4. Goldberg D.E., “Genetic Algorithms in Search, Optimisation and Machine Learning”, Addison Wesley Publishing Company.
5. Rajasekaran, S. & Vijayalakshmi, G.A., “Neural Networks, Fuzzy Logic and Genetic Algorithms-Synthesis and Applications”, PHI Learning Private Ltd, 2012
6. Krishnamoorthy E.V. and Sen S.K., “Numerical Algorithms”, Affiliated East West Press
7. Haldar A & Mahadevan S. Probability, Reliability and Statistical Methods in Engineering Design, John Wiley & Sons, Inc. New York, 2000
8. Haldar A & Mahadevan S. Reliability Assessment Using Stochastic Finite Element Analysis, John- Wiely & Sons Inc., New York, USA, 2000
9. Ayyub B M, McCuen R H. Probability, Statistics and Reliability for Engineers and Scientists, Chapman & Hall, Florida, USA, 2000.
10. Ang A H S & Tang W H. Probability Concepts in Engineering Planning and Design, Vol I, John Wiley, New York, 1984
11. Nowak A.S. and Collins K.R. Reliability of Structures, McGraw-Hill International Editions, USA, 2000.
12. Papoulis A. Probability, Random Variables and Stochastic Processes, McGraw-Hill, New York, USA, 1991.
13. Ranganathan R. Structural Reliability Analysis & Design. Jaico Publishing House, Mumbai, India, 1999.
14. Melchers R E. Structural Reliability: Analysis and Prediction, John Wiley, Chichester, 1999

APJ ABDUL KALAM
TECHNOLOGICAL
UNIVERSITY

SEMESTER I

PROGRAM ELECTIVE II



CODE	COURSE NAME	CATEGORY	L	T	P	CREDIT
221ECE042	ADVANCED DESIGN OF STEEL STRUCTURES	PROGRAM ELECTIVE 2	3	0	0	3

Preamble: The proposed course is expected to enhance and strengthen the knowledge on detailed design methods for steel structures, in compliance with Indian and International codes. Analysis and design of bolted and welded connections, Design of steel members under special loads like fire and blast loads, design of industrial structures with gantry girders and design of light gauge structures will be discussed.

Course Outcomes; After the completion of the course the student will be able to

CO 1	Design bolted joints
CO 2	Design of welded joints
CO 3	Design light gauge columns, beams, and tension members
CO 4	Understand fire and blast loads
CO 5	Understand various elements in an industrial building and Design gantry girders
CO 6	Draw structural details of bolted and welded joints, light gauge sections and gantry girder.

Mapping of course outcomes with program outcomes

	PO 1	PO 2	PO 3	PO 4	PO 5	PO 6	PO 7
CO 1	1	2	3	2	2	1	1
CO 2	1	2	3	2	2	1	1
CO 3	1	2	3	2	2	1	1
CO 4	1	2	3	2	2	1	1
CO 5	1	2	3	2	2	1	1
CO 6	1	2	3	2	2	1	1

Assessment Pattern

Bloom's Category	End Semester Examination
Apply	25%
Analyse	25%
Evaluate	20%
Create	30%

Total Marks	CIE	ESE	ESE Duration
100	40	60	2.5 hours

Continuous Internal Evaluation Pattern:**Continuous Internal Evaluation: 40 marks**

Preparing a review article based on peer reviewed original publications (minimum 10 publications shall be referred): 15 marks

Course based task/Seminar/Data collection and interpretation: 15 marks

Test paper, 1 no.: 10 marks

Test paper shall include minimum 80% of the syllabus.

End Semester Examination Pattern:

The end semester examination will be conducted by the respective College. There will be two parts; Part A and Part B. Part A will contain 5 numerical/short answer questions with 1 question from each module, having 5 marks for each question (such questions shall be useful in the testing of knowledge, skills, comprehension, application, analysis, synthesis, evaluation and understanding of the students). Students should answer all questions. Part B will contain 7 questions (such questions shall be useful in the testing of overall achievement and maturity of the students in a course, through long answer questions relating to theoretical/practical knowledge, derivations, problem solving and quantitative evaluation), with minimum one question from each module of which student should answer any five. Each question can carry 7 marks.

Note: The marks obtained for the ESE for an elective course shall not exceed 20% over the average ESE mark % for the core courses. ESE marks awarded to a student for each elective course shall be normalized accordingly. For example, if the average end semester mark % for a core course is 40, then the maximum eligible mark % for an elective course is $40+20 = 60$ %

Reg. No.....

Name:.....

**APJ ABDUL KALAM TECHNOLOGICAL UNIVERSITY
FIRST SEMESTER M. TECH DEGREE EXAMINATION**

ADVANCED DESIGN OF STEEL STRUCTURES

Max. Marks: 60

Duration: 3 Hours

PART A

Answer all questions. Each question carries 5 marks (5× 5=25Marks)

1. Why are HSFG bolts preferred in joints subjected to fatigue? What do you mean by Prying action?
2. Discuss the advantages and disadvantages of welded connections over bolted connections.
3. What is local buckling of thin elements and what do you mean by post buckling strength of light gauge steel members?
4. Draw a plot showing the stress-strain relationships of structural steel marking salient points.
5. Explain sway and non-sway frames. Include at least two examples of each type using appropriate figures.

PART B

Answer any five questions (5×7=35Marks)

6. Design a seat connection for a factored beam end reaction of 110kN. The beam section is ISMB 250 @ 36.6 kg/m connected to the flange of column section ISHB 200 @ 36.6 kg/m. Use Fe 410 grade steel and bolt 4.6 grade.
7. Design a welded stiffened seat and clip connection for an ISMB 350 @ 51.4 kg/m to transmit a factored end reaction 320 kN to a column ISHB 300 @ 57.6 kg/m. Steel Fe 410 grade and use fillet weld of required size.
8. Two channels of 180 mm x 80 mm section with bent lips as shown in figure 1 are connected with webs to act as beam. The thickness of the plate is 2.5 mm and the depth of the lip is 25mm. The beam has an effective span of 4.1 m. Determine the allowable load per m run on the beam. The dimensions in the figure 2 are in mm. Use $f_y = 235 \text{ N/mm}^2$.

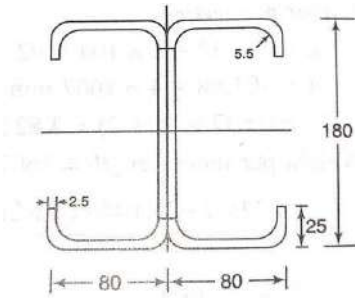

9. A light gauge rectangular box- section with overall cross-sectional dimensions of 200 mm x150 mm (out- to-out), thickness 2.5 mm and fillets of radius 2.5 mm at each of the 4 inside corners, is being employed as a column over an effective length of 3.2 m. Compute the safe load on the column is steel used is having yield stress of 2400 kg/cm².
10. Explain the design principles for design of structures against fire, blast and impact loads.
11. Explain the knees and valleys in the steel structures with neat figures.
12. A hand operated 50 kN overhead crane is provided in a workshop. The details are given below: i) Centre to centre between gantry girders = 16 m (ii) Span of the gantry girder = 6 m (iii) Weight of the crane = 40 kN Gantry (iv) Wheel spacing = 3 m (v) Weight of the crab = 10 kN (vi) Maximum edge distance = 1 m. Design a simply supported gantry girder, assuming the flange is laterally supported.

Module 1

Bolted Connections: Classification (Simple, Rigid, Semi rigid)–Moment rotation Characteristics–Failure modes of a joint Types of bolts–Bearing and High strength bolts–Prying force–Beam to Column connections–Design of seat angle–Unstiffened–Design of seat angle–Stiffened Web angle & end plate connections, Beam and column bolted splices–Design of framed beam connection–continuous beam to beam connection.

Module 2

Welded Connections: Structure and properties of weld metal. Beam to-column connections–Angle seat Stiffened beam seat connection–Web angle and end plate connections–Beam and column welded splices Tubular connections–Parameters of an in plane joint Welds in tubular joints–Curved weld length at intersection of tubes–SHS and RHS tubes–design parameters–Weld defects.

Module 3

Design of Light Gauge Structures: Design of light gauge steel structures: Introduction–Types of cross sections–Materials Local and post buckling of thin elements–Stiffened and multiple stiffened compression elements–Tension members– Beams and deflection of beams–Combined stresses and connections.

Module 4

Design of Blast, Impact, Snow and Fire-resistant structures: Blast loads–impact loads–Ice-infested loads on structures–Fire loads–Fire-resistant design–Simple problems in Fire loads calculations.

Module 5

Design of Industrial buildings and Gantry girders: Design of members subjected to lateral loads and axial loads–Sway and non-sway frames, bracings, and bents–Rigid frame joints–Knees for rectangular frames and pitched roofs - Knees with curved flanges–Valley joints - Rigid joints in multistorey buildings–Vierendeel girders–Design of gantry girders–Introduction–Loading consideration–Selection of gantry girder–Position of moving load for maximum effects, profile of gantry girder, limitation on vertical deflection–Design of gantry girders.

No	Topic	No. of Lectures
1	Bolted Connections (9)	
1.1	Classification (Simple, Rigid, semi rigid)–Moment rotation Characteristics–Failure modes of a joint.	1
1.2	Types of bolts - Bearing and High strength bolts- Prying force–Beam to Column connections.	1
1.3	Design of seat angle – Unstiffened.	1
1.4	Design of seat angle – Stiffened.	1
1.5	Web angle and end plate connections.	1
1.6	Beam and column bolted splices.	1
1.7	Design of framed beam connection – continuous beam to beamconnection.	1
2	Welded Connections (8)	
2.1	Structure and properties of weld metal–Beam to-column connections–Angle seat.	2
2.2	Stiffened beam seat connection.	1
2.3	Web angle and end plate connections.	2
2.4	Beam and column welded splices.	1
2.5	Tubular connections - Parameters of an in plane joint Welds in tubular joints.	1
2.6	- Curved weld length at intersection of tubes – SHS and RHS tubes - design parameters- Weld defects.	1
3	Design of Light Gauge Structures (9)	
3.1	Design of light gauge steel structures: Introduction – Types of crosssections – Materials.	1
3.2	Local and post buckling of thin elements.	1
3.3	Stiffened and multiple stiffened compression elements.	2
3.4	Tension members.	2
3.5	Beams and deflection of beams.	2
3.6	Combined stresses and connections.	1
4	Design of Blast, Impact, Snow and Fire-resistant structures (7)	
4.1	Blast loads - impact loads.	1
4.2	Ice-infested loads on structures.	1
4.3	Fire loads.	1
4.4	Fire-resistant design.	2
4.5	Simple problems in Fire loads calculations.	2
5	Design of Industrial buildings and Gantry girders (7)	
5.1	Design of members subjected to lateral loads and axial loads.	1
5.2	Swayand non-sway frames, bracings, and bents.	1
5.3	Rigid frame joints - Knees for rectangular frames and pitched roofs - Knees with curved flanges.	1

5.4	Valley joints - Rigid joints in multistorey buildings - Vierendeel girders.	CIVIL ENGINEERING-CE	4
5.5	Design of gantry girders - Introduction - Loading consideration- Selection of gantry girder.		1
5.6	Position of moving load for maximum effects, profile of gantry girder, limitation on vertical deflection.		1
5.7	Design of gantry girders.		1

Reference Books

1. Gaylord, Design of steel structures, McGraw Hill, New York.
2. Duggal.S.K., Limit state design of steel structures, McGraw-Hill.
3. Subramanian.N, Design of steel structures, Oxford.
4. Wie-Wen Yu.,Cold-Formed Steel Structures, McGraw Hill Book Company.
5. Hetherington John and Smith P. D., Blast, and ballistic loading of structures.

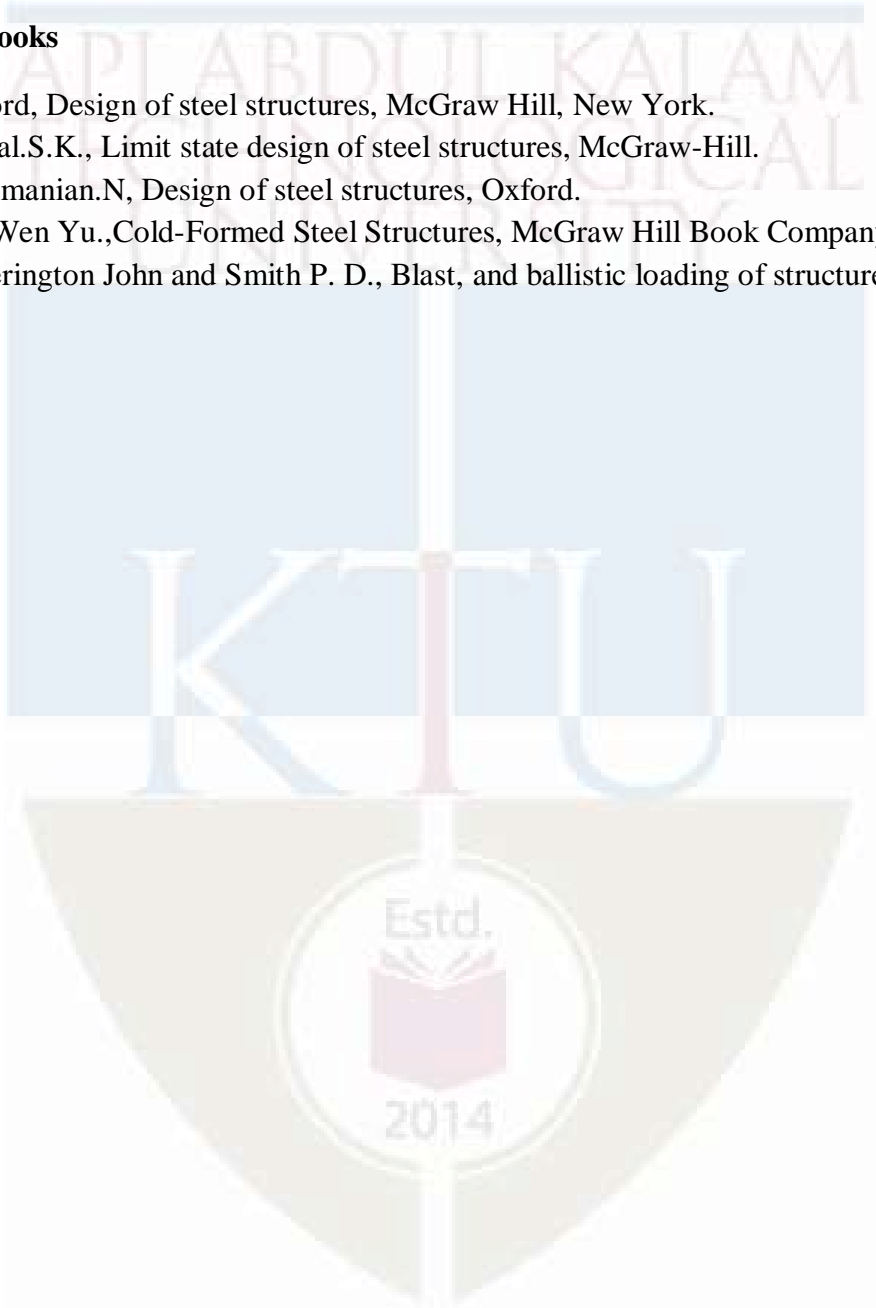

CODE	COURSE NAME	CATEGORY	L	T	P	CREDIT
22IECE043	FORENSIC ENGINEERING AND REHABILITATION OF STRUCTURES	PROGRAM ELECTIVE 2	3	0	0	3

Preamble: The proposed course is expected to enhance and strengthen the knowledge on role and responsibility of a forensic engineer, different cause of deterioration in structures and its prevention, the uses of different NDT equipment's, awareness regarding the structural health monitoring, knowledge in Different modern techniques of retrofitting will be discussed.

Course Outcomes: After the completion of the course the student will be able to

CO 1	To understand role and responsibility of a forensic engineer
CO 2	To understand different cause of deterioration in structures and its prevention
CO 3	To gain adequate knowledge for the uses of different NDT equipments
CO 4	To get awareness regarding the structural health monitoring
CO 5	To gain adequate knowledge in Different modern techniques of retrofitting

Mapping of course outcomes with program outcomes

	PO 1	PO 2	PO 3	PO 4	PO 5	PO 6	PO 7
CO 1	1	2	3	2	2	1	1
CO 2	1	2	3	2	2	1	1
CO 3	1	2	3	2	2	1	1
CO 4	1	2	3	2	2	1	1
CO 5	1	2	3	2	2	1	1
CO 6	1	2	3	2	2	1	3

Assessment Pattern

Bloom's Category	End Semester Examination
Apply	25%
Analyse	25%
Evaluate	20%
Create	30%

Mark distribution

Total Marks	CIE	ESE	ESE Duration
100	40	60	2.5 hours

Continuous Internal Evaluation Pattern:

Continuous Internal Evaluation: 40 marks

Preparing a review article based on peer reviewed original publications (minimum 10 publications shall be referred): 15 marks

Course based task/Seminar/Data collection and interpretation: 15 marks

Test paper 1 no.: 10 marks

Test paper shall include minimum 80% of the syllabus.

End Semester Examination Pattern:

The end semester examination will be conducted by the respective College. There will be two parts; Part A and Part B. Part A will contain 5 numerical/short answer questions with 1 question from each module, having 5 marks for each question (such questions shall be useful in the testing of knowledge, skills, comprehension, application, analysis, synthesis, evaluation and understanding of the students). Students should answer all questions. Part B will contain 7 questions (such questions shall be useful in the testing of overall achievement and maturity of the students in a course, through long answer questions relating to theoretical/practical knowledge, derivations, problem solving and quantitative evaluation), with minimum one question from each module of which student should answer any five. Each question can carry 7 marks.

Note: The marks obtained for the ESE for an elective course shall not exceed 20% over the average ESE mark % for the core courses. ESE marks awarded to a student for each elective course shall be normalized accordingly. For example, if the average end semester mark % for a core course is 40, then the maximum eligible mark % for an elective course is $40+20 = 60$ %.

Model Question Paper

Pages: 2

E

Reg. No.....

Name:

**APJ ABDUL KALAM TECHNOLOGICAL UNIVERSITY
FIRST SEMESTER M.TECH DEGREE EXAMINATION
STRUCTURAL ENGINEERING**

**221ECE043 FORENSIC ENGINEERING AND REHABILITATION OF
STRUCTURES**

Maximum Marks: 60

Duration : 3 Hours

PART A

Answer all questions. Each question carries 5 marks (5 × 5=25 Marks)

- 1 Give the qualities expected for a Forensic Engineer.
- 2 Give a classified list of common causes of deterioration of concrete structures.
- 3 What are non-destructive tests? Discuss the usefulness and significance of NDT.
- 4 Explain the needs and benefits of Structural Health Monitoring.
- 5 Explain how cracking is treated by external pre-stressing.

PART B

Answer any five questions (5 × 7=35 Marks)

- 6 i) What are the duties and responsibilities of a Forensic Engineer?
ii) In the context of construction industry, explain the terms responsibility and accountability.
- 7 i) Discuss the errors in design and mistakes in construction those may lead to the premature failure of concrete structures.
ii) How does i) acid attack and ii) freezing and thawing affect the health of reinforced concrete structures?
- 8 i) What are the different types of maintenances? Discuss the importance of each one.
ii) Give a classified list of environmental factors causing deterioration in concrete structures.

- CIVIL ENGINEERING-CE4
- 9 i) What is meant by acid attack? How does it occur? What are its effects on concrete structures?
- ii) Describe the principle, procedure, advantages and limitations of ultrasonic pulse velocity test.
- 10 i) Explain Fibre Optic method for prediction of structural weakness.
- ii) Give a list of methods for repair of concrete structures.
- 11 i) As a forensic engineer, how will you select a method for your client?
- ii) Explain how cracking is treated by external pre-stressing.
-

Syllabus and Course Plan (For 3 credit courses, the content can be for 40 hrs and for 2 credit courses, the content can be for 26 hrs. The audit course in third semester can have content for 30 hours).

Syllabus:

Failure of Structures: Review of the construction theory – performance problems – responsibility and accountability– Causes of distress in structural members– Design and material deficiencies – over loading. Environmental Problems and Natural Hazards: Effect of corrosive, chemical and marine environment– Preventive measures, maintenance and inspection. Diagnosis and Assessment of Distress: Visual inspection – non-destructive tests – ultrasonic pulse velocity method– Rebound hammer technique – pull-out tests – Windsor probe test– Crack detection techniques. Structural Health Monitoring: Introduction – Needs and Benefits of Structural Health Monitoring– Fibre Optic method for prediction of structural weakness –Methods of repair of cracks Modern Techniques of Retrofitting: Structural first aid after a disaster – guniting, jacketing – use of chemicals in repair–Strengthening by prestressing. Repair of steel structures.

Course Plan:

No	Topic	No. of Lectures
1	Failure of Structures	
1.1	Review of the construction theory – performance problems – responsibility and accountability	4
1.2	Causes of distress in structural members	3
1.3	Design and material deficiencies – over loading	4
2	Environmental Problems and Natural Hazards	
2.1	Effect of corrosive, chemical and marine environment	4
2.2	Preventive measures, maintenance and inspection	3
3	Diagnosis and Assessment of Distress	
3.1	Visual inspection – non-destructive tests – ultrasonic pulse velocity method	4
3.2	Rebound hammer technique – pull-out tests – Windsor probe test	3

3.3	Crack detection techniques	CIVIL ENGINEERING-CE4
4	Structural Health Monitoring	
4.1	Introduction – Needs and Benefits of Structural Health Monitoring	2
4.2	Fibre Optic method for prediction of structural weakness – Methods of repair of cracks	4
5	Modern Techniques of Retrofitting	
5.1	Structural first aid after a disaster – guniting, jacketing – use of chemicals in repair	4
5.2	Strengthening by prestressing. Repair of steel structures.	3

Reference Books

1. Sidney M Johnson, Deterioration, Maintenance and Repairs of Structures, Mc Graw Hill Book Company, New York
2. Dovkaminetzky, Design and Construction Failures, Galgotia Publication., NewDelhi
3. Jacob Field and Kenneth L Carper, Structural Failures, Wiley Europe
4. Design and Construction Failures, Dovkaminetzky, Galgotia Publication, New Delhi, 2009.
5. Concrete – Building Pathology, Macdonald S, John Wiley and Sons, 2002.
6. Forensic Structural Engineering Handbook, Robert. T Ratay, Mc Graw Hill, 2009.
7. Understanding Building Failures, James Douglas and Bill Ransom, Taylor and Francis Group, 2007.
8. Concrete Repair and Maintenance, Peter H Emmons, Galgotia Publications, 2010.



CODE	COURSE NAME	CATEGORY	L	T	P	CREDIT
221ECE044	DESIGN OF OFFSHORE STRUCTURES	PROGRAM ELECTIVE 2	3	0	0	3

Preamble: The course aims to provide a basic understating of the theory and concepts of analysis and design of Offshore Structures. After the completion of the subject the student is expected to apply the knowledge to design Jacket Platforms which is most relevant for Indian Offshore Region.

Course outcomes: After the completion of the course the student will be able to

CO 1	Understand the basics of wave mechanics and estimate the wave kinematics for regular and random waves
CO 2	Estimate the functional and environmental loads acting on offshore structures.
CO 3	Apply theoretical principles and analytical models in the design of offshore structures conforming to code provisions
CO 4	Design tubular members and joints following API specifications
CO 5	Evaluate the fatigue life of Tubular joints of Jacket Platforms
CO 6	Practice the profession of Structural engineering with adequate proficiency in analysis and design of Offshore Structures

Mapping of course outcomes with program outcomes

	PO 1	PO 2	PO 3	PO 4	PO 5	PO 6	PO 7
CO 1			3	3	3	3	
CO 2			3	3	3	3	
CO 3			3	3	3	3	
CO 4			3	3	3	3	
CO 5			3	3	3	3	
CO 6			3	3	3	3	

Assessment Pattern

Bloom's Category	End Semester Examination
Apply	10
Analyse	10
Evaluate	20
Create	20

Mark distribution

Total Marks	CIE	ESE	ESE Duration
100	40	60	2.5 hours

Continuous Internal Evaluation Pattern:

Continuous Internal Evaluation: 40 marks

Preparing a review article based on peer reviewed

Original publications (minimum 10 publications shall be referred) : 15 marks

Course based task/Seminar/Data collection and interpretation : 15 marks

Test paper, 1 no. : 10 marks

Test paper shall include minimum 80% of the syllabus

End Semester Examination Pattern:

The end semester examination will be conducted by the respective College. There will be two parts; Part A and Part B. Part A will contain 5 numerical/short answer questions with 1 question from each module, having 5 marks for each question (such questions shall be useful in the testing of knowledge, skills, comprehension, application, analysis, synthesis, evaluation and understanding of the students). Students should answer all questions. Part B will contain 7 questions (such questions shall be useful in the testing of overall achievement and maturity of the students in a course, through long answer questions relating to theoretical/practical knowledge, derivations, problem solving and quantitative evaluation), with minimum one question from each module of which student should answer any five. Each question can carry 7 marks.

Note: The marks obtained for the ESE for an elective course shall not exceed 20% over the average ESE mark % for the core courses. ESE marks awarded to a student for each elective course shall be normalized accordingly. For example, if the average end semester mark % for a core course is 40, then the maximum eligible mark % for an elective course is $40 + 20 = 60$ %.

PART A

(Answer all questions-Each question carries 5 marks)

1. What is a non-linear wave theory? How are they classified? Differentiate with small- amplitude wave theory.
2. Explain the procedure for estimating wind force on an offshore structure.
3. What are the methods of estimating maximum global wave forces on a jacket structure, Explain
4. Why tubular members are commonly used in offshore structures? What are the important factors affecting the strength of a tubular structure?
5. What is stress concentration? Describe the methods for reducing it in tubular joints?

PART B

(Answer any Five questions-Each question carries 7 marks)

1. (a) Explain the classification of offshore structures with sketches.
(b) A wave flume is filled with fresh water to a depth of 5 m. A wave of height 1 m and period 4 s is generated. Calculate the celerity, group celerity, energy and power.
2. If a pressure sensing instrument is set up at 5 m below SWL in a water depth of 20 m, determine the phase distribution of pressure head. Determine the maximum dynamic pressure. The wave height is 3 m and period is 8s and $\gamma = 10 \text{ kN/m}^3$. Also determine the above for a wave with period 4 s.
3. A pile of diameter 0.75m is to be installed in a water depth of 100m. The wave height and wave period are 6m and 10s respectively with $C_d = 1$ and $C_m = 2$. Compute the maximum drag force per unit length at a depth of 20m below SWL.
4. Describe the linear diffraction theory. What are the assumptions and boundary conditions?
5. Main leg member of a jacket platform is 1500mm OD x 25mm thick. Effective length of the member is 18m. If the actual axial load is 75% of the maximum permissible axial load, find the additional bending moment that can be resisted by it. Take $F_y = 250 \text{ MPa}$, $E = 200 \text{ GPa}$
6. Tubular member of an offshore structure is subjected to nominal stresses, corresponding number of cycles per year is given below. S_f for member is

found to be 2.9. determine the fatigue life of the member. The S-N curve is represented by $\log N = 12.164 - 3 \log S$ where S is the hot spot stress range in

Nominal stress (N/mm ²)	59	50	40	28	10
Cycles per year	6	150	3340	64050	1142800

N/mm².

7. K- joint with the chord and brace details shown below is subjected to axial in plane and out of plane BM. Neglect the stress in the chord member. Yield strength of the connection shall be taken as 345Mpa. Check the safety of the joint.

Data :

Brace 1 $d_1 = 508 \text{ mm}$ $t_1 = 15.88 \text{ mm}$ $\theta_1 = 45^\circ$

Brace 2 $d_2 = 406 \text{ mm}$ $t_2 = 12.7 \text{ mm}$ $\theta_2 = 30^\circ$

Chord $D = 762 \text{ mm}$ $T = 19 \text{ mm}$

Gap between braces $g = 50 \text{ mm}$

Brace 1 $P = 900 \text{ kN}$ $M_{ip} = 275 \text{ kNm}$ $M_{op} = 125 \text{ kNm}$

Brace 2 $P = 1275 \text{ kN}$ $M_{ip} = 225 \text{ kNm}$ $M_{op} = 145 \text{ kNm}$

Syllabus

Module -I

Basics of Wave Mechanics – Introduction to Offshore structures-classification-fixed, compliant-floating platforms-examples- Wave Theories: Basics of wave motion- Small amplitude wave theory- velocity potential- dispersion relationship- wave kinematics- Pressure under wave-wave energy and power (Numerical exercises to be done)- Finite amplitude waves- classification- Random waves-Wave spectral density-Mathematical spectrum models- Design Wave Method-Spectral Method.

Module -II

Loads on Offshore Structures- Loads on Off shore Structures: Functional loads- Environmental loads-Wave, Wind, and Current Forces- Estimation as per API recommendations - Morison equation- force on vertical and inclined piles- Numerical examples -Wave forces on large structures-linear diffraction theory.

Analysis and Design Concepts of Jacket Platforms- Concepts of Fixed Platform Jacket: Components and Functions, Design Wave Method-Spectral Method- Extreme and Operating Conditions -Estimation of Maximum Wave forces and Moments Maximum Base Shear Method- In-service and Pre-service loads- Principles of Static and dynamic analyses of fixed platforms-In-Place Analysis-Analytical modelling of jacket platforms-deck, jacket and foundation

Module- IV

Steel Tubular Member Design- Principles of WSD and LRFD; Allowable stresses and Partial Safety Factors API specifications for steel-allowable stresses-Design procedure Tubular Members, Slenderness effects; Column Buckling- Design for Hydrostatic pressure; Design for combined axial and bending stresses (API RP 2A guidelines)-Numerical Examples- Design for Hydrostatic pressure; Design for combined axial and bending stresses (API RP 2A guidelines)-Numerical Examples.

Module- V

Fatigue in Tubular Joints - Tubular Joints-Classification-Analysis of Joints- Stress Concentration in Tubular joints, S-N curves-Cumulative damage ratio-Fatigue analysis methods- Palmgren- Miner rule- evaluation of Fatigue life of components-numerical examples

Course Plan

No	Topic	No. of Lectures
1	Basics of Wave Mechanics	9
1.1	Introduction to Offshore structures-classification-fixed, compliant-floating platforms-examples	2
1.2	Wave Theories: Basics of wave motion- Small amplitude wave theory- velocity potential- dispersion relationship- wave kinematics- Pressure under wave-wave energy and power (Numerical exercises to be done)- Finite amplitude waves- Classification	4
1.3	Random waves-Wave spectral density-Mathematical spectrum models- Design Wave Method-Spectral Method	3
2	Loads on Offshore Structures	7
2.1	Loads on Off shore Structures: Functional loads- Environmental loads-Wave, Wind, and Current Forces- Estimation as per API recommendations	3
2.2	Morison equation- force on vertical and inclined piles- Numerical examples	3

2.3	Wave forces on large structures-linear diffraction theory	CIVIL ENGINEERING-CE4
3	Analysis and Design Concepts of Jacket Platforms	8
3.1	Concepts of Fixed Platform Jacket: Components and Functions, Design Wave Method-Spectral Method- Extreme and Operating Conditions -Estimation of Maximum Wave forces and Moments Maximum Base Shear Method	3
3.2	In-service and Pre-service loads- Principles of Static and dynamic analyses of fixed platforms-In-Place Analysis	2
3.3	Analytical modelling of jacket platforms-deck, jacket and foundation	3
4	Steel Tubular Member Design	8
4-1	Principles of WSD and LRFD; Allowable stresses and Partial Safety Factors API specifications for steel-allowable stresses	2
4.2	Design-procedure Tubular Members, Slenderness effects; Column Buckling.	3
4.3	Design for Hydrostatic pressure; Design for combined axial and bending stresses (API RP 2A guidelines)-Numerical Examples	3
5	Fatigue in Tubular Joints	8
5.1	Tubular Joints-Classification-Analysis of Joints	2
5.2	Stress Concentration in Tubular joints, S-N curves- Cumulative damage ratio-Fatigue analysis methods	3
5.3	Palmgren- Miner rule- evaluation of Fatigue life of components-numerical examples	3

Reference Books

1. Dr. Sundar V., "Ocean Wave Mechanics -Applications in Marine Structures" John Wiley and Sons Ltd
2. Chakrabarti, S.K., "Hydrodynamics of Offshore Structures", Computational Mechanics Publications, Southampton, Boston
3. Sreenivasan Chandrasekharan, "Dynamic Analysis and Design of Offshore Structures" Second Edition, Springer
4. API-Recommended Practice for Planning, Designing and Constructing Fixed Offshore Platforms. API-RP2A-WSD (2014)-API-RP2A-LRFD (1993)

CODE	COURSE NAME	CATEGORY	L	T	P	CREDIT
221ECE045	ANALYSIS AND DESIGN OF SUBSTRUCTURES	PROGRAM ELECTIVE 2	3	0	0	3

Preamble: Goal of this course is to expose the students to the concepts of soil structure interaction and design of various sub structures. By the completion of this course the students will be able to analyse and design different types of substructures and thereby develop solutions for real world problems.

Course Outcomes: After the completion of the course the student will be able to

CO 1	Understand the soil-structure interaction
CO 2	Analyse and Design shallow foundation
CO 3	Design Pile foundation and Pile cap
CO 4	Analyse and Design Retaining walls
CO5	Design various components of Well foundation
CO6	Analysis and Design Machine foundation

Mapping of course outcomes with program outcomes

	PO 1	PO 2	PO 3	PO 4	PO 5	PO 6	PO 7
CO 1	1			3	1	2	
CO 2	2			3	3	3	
CO 3	3			3	3	3	
CO 4	3			3	3	3	

Assessment Pattern

Bloom's Category	End Semester Examination (Marks)
Understand	20
Apply	20
Analyse	10
Evaluate	10

Mark distribution

Total Marks	CIE	ESE	ESE Duration
100	40	60	2.5 hours

Continuous Internal Evaluation Pattern:

CIVIL ENGINEERING-CE4

Continuous Internal Evaluation: 40 marks

Preparing a review article based on peer reviewed original publications (minimum 10 publications shall be referred) : 15 marks

Course based task/Seminar/Data collection and interpretation : 15 marks

Test paper, 1 no. : 10 marks

Test paper shall include minimum 80% of the syllabus

End Semester Examination Pattern:

The end semester examination will be conducted by the respective College. There will be two parts; Part A and Part B. Part A will contain 5 numerical/short answer questions with 1 question from each module, having 5 marks for each question (such questions shall be useful in the testing of knowledge, skills, comprehension, application, analysis, synthesis, evaluation and understanding of the students). Students should answer all questions. Part B will contain 7 questions (such questions shall be useful in the testing of overall achievement and maturity of the students in a course, through long answer questions relating to theoretical/practical knowledge, derivations, problem solving and quantitative evaluation), with minimum one question from each module of which student should answer any five. Each question can carry 7 marks.

Note: The marks obtained for the ESE for an elective course shall not exceed 20% over the average ESE mark % for the core courses. ESE marks awarded to a student for each elective course shall be normalized accordingly. For example, if the average end semester mark % for a core course is 40, then the maximum eligible mark % for an elective course is $40+20 = 60$ %.



APJ ABDUL KALAM TECHNOLOGICAL UNIVERSITY

FIRST SEMESTER M. TECH DEGREE EXAMINATION, Month & Year

221ECE045: Analysis and Design of Substructures

Maximum: 60marks

Time 2.5 hrs

PART A (Answer all questions: Each question carries 5 marks)

1. Draw the contact stress distribution below a rigid circular footing and explain
2. What is a pile cap. Specify the functions of a pile cap.
3. Explain the different types of retaining walls
4. Define scour depth and grip length
5. Explain vibration isolation

PART B (Answer any 5 questions: Each question carries 7 marks)

6. Design the strap footing to carry two column loads of 1100kN and 2020kN. The columns are 6m between the centres. The sizes of the columns are 500 x 500 mm and 600 x 600 mm respectively. The footing areas under the columns are respectively 1.2 mx3m and 3m x 3m connected by the suitable strap. The safe bearing capacity of the soil is 205 kN/m², use M20 concrete and Fe 415 steel
7. Design a reinforced concrete combined rectangular footing for two columns located 3m apart. The overall size of the column are 40 x 40 cm and 60 x 60 cm and the loads on them are 120 tones and 160 tones respectively. The space available for the width of the footing is restricted to 10cm. The safe bearing capacity of the soil is 30 tones per m². Use M15 concrete and Mild steel for reinforcement.
8. The foundation of a structure consist of 16 piles. It carry a total load of 10,000 kN. The piles are 400 mm x 400 mm size and are 8m long. They are spaced at 1m centre to centre. Design one of the piles. Use M20 concrete and Fe 415 steel.
9. Design a pile cap for a column size 500 mm x 500 mm carrying a load of 3000kN supported by 4 piles. The size of the piles may be taken as 300 mm x 300 mm. The c/c distance between the piles is 1.5m. Use M20 concrete and Fe 415 steel
10. The stem of the cantilever retaining wall is 4.5 m, retains soil of specific weight 20000 N/m³ and having angle of repose of 30° Top surface of the retained soil is level. Design the retaining wall. The safe bearing of the soil is 200kN/m². Use M20 concrete and Fe 415 steel.

11. Design the outside well diameter of a caisson to be sunk through 40m of sand and water bed rock if the allowable bearing capacity is 2200 kN/m². The caisson receives a load of 5000kN from the super structure. The mantle friction is 32kN/m². Test the feasibility of sinking. Also calculate the thickness of seal.
12. The exciting force in a constant force amplitude excitation is 100 kN. The natural frequency of the machine foundation is 3 Hz. The damping factor is 0.30. Evaluate the magnification factor and the transmitted force at an operating frequency of 6 Hz

Syllabus

Module 1

Soil-structure interaction: Introduction to soil-structure interaction - Soil-structure interaction problems. Contact pressure distribution beneath rigid and flexible footing on sand and clay. Contact pressure distribution beneath raft. Selection of foundation .

Shallow foundations: Structural design of spread footing, combined footing and raft foundation.

Module 2

Pile foundation: Introduction- load carrying capacity -Settlement of single pile-Laterally loaded piles-Borm's method-Ultimate lateral resistance of piles- Structural Design of straight Piles and Structural Design of pile cap

Module 3

Retaining walls:Types-Stability analysis of cantilever retaining wall against overturning and sliding-Bearing capacity considerations-structural design of retaining walls.

Module 4

Well foundation: Introduction to well foundations-Types-Elements of well foundations-Grip length- depth of scour-load carrying capacity-Design of well cap, well steining, well curb, cutting edge and bottom plug.

Module 5

Machine foundation: Types of machine foundation-Basic principles of design of machine foundation-Dynamic properties of soil-vibration analysis of machine foundation-Design of foundation for reciprocating machines and impact machines-Vibration isolation

No	Topic	No. of Lectures
1	Soil-structure interaction and Shallow foundations	
1.1	Introduction to soil-structure interaction - Soil-structure interaction problems.	2
1.2	Contact pressure distribution beneath rigid and flexible footing on sand and clay. Contact pressure distribution beneath raft.	3
1.3	Types and Selection of foundation. Structural design of spread footing, combined footing and raft foundation.	3
2	Pile foundation	
2.1	Pile foundation: Introduction- load carrying capacity - Settlement of single pile-	2
2.2	Laterally loaded piles-Borm's method-Ultimate lateral resistance of piles-	3
2.3	Structural Design of straight Piles and Structural Design of pile cap	4
3	Retaining walls	
3.1	Retaining walls-Types-Stability analysis of cantilever retaining wall against overturning and sliding	3
3.2	Bearing capacity considerations-structural design of retaining walls	4
4.	Well foundation	
4.1	Well foundation: Introduction to well foundations-Types-Elements of well foundations-	2
4.2	Grip length- depth of scour-load carrying capacity-	2
4.3	Design of well cap,well steining,well curb,cutting edge and bottom plug	4
5	Machine foundation	
5.1	Machine foundation: Types of machine foundation-Basic principles of design of machine foundation	2
5.2	Dynamic properties of soil-vibration analysis of machine foundation-	3
5.3	Design of foundation for reciprocating machines and impact machines-vibration isolation	3

Total hours-8+9+7+8+8=40 hrs

Reference Books

- 1.Bowles. J.E., " Foundation Analysis and Design", McGraww Hill Publishing co., New York, 1997.
- 2.Swamy Saran, Analysis and Design of substructures, Oxford and IBH Publishing Co. Pvt.Ltd., 2006.

3. Tomilson.M.J, “Foundation Design and Construction”, Longman, Sixth Edition, New Delhi, 2009
4. Varghese.P.C, “Design of Reinforced Concrete Foundations”-PHI learning private limited, New Delhi-2009

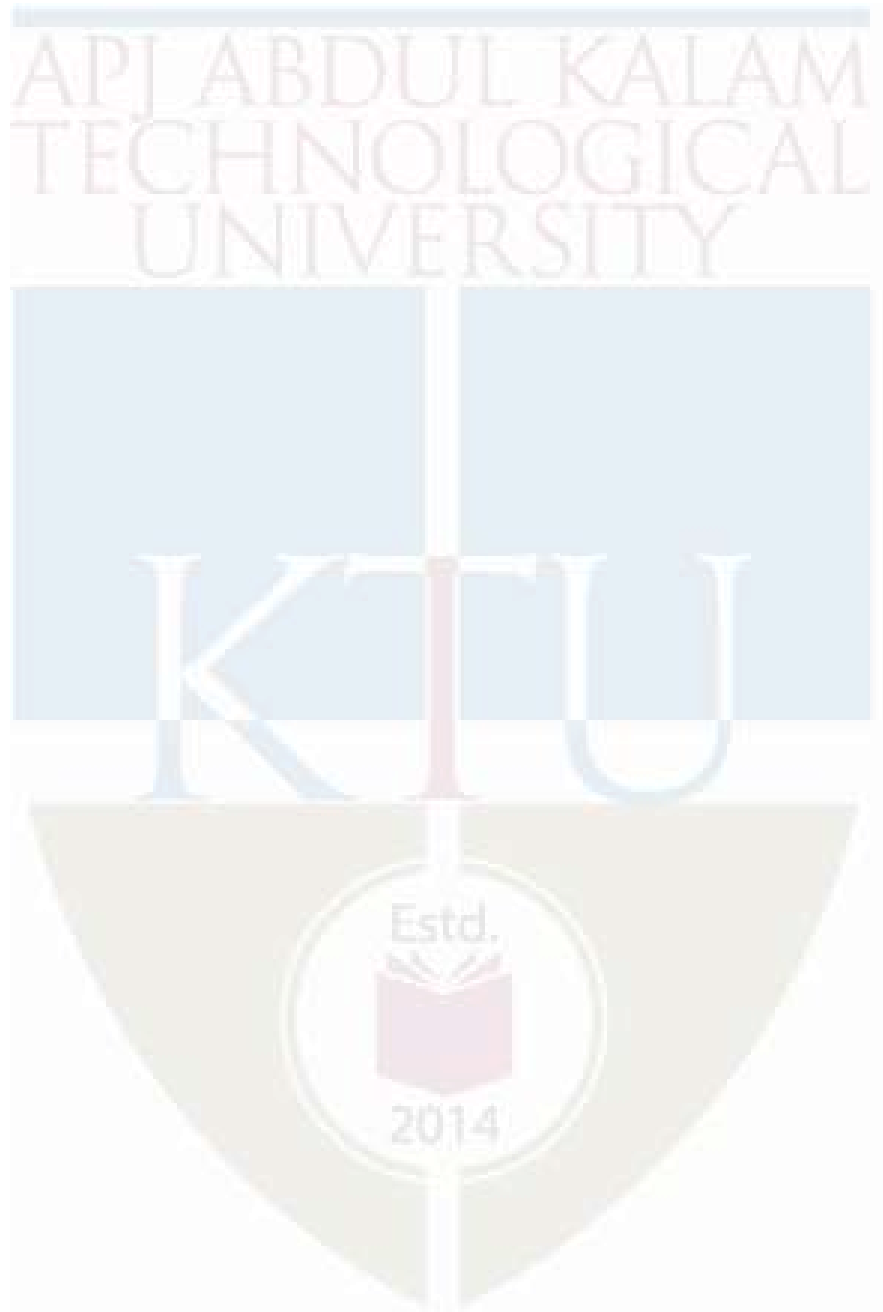

CODE	COURSE NAME	CATEGORY	L	T	P	CREDIT
221RGE100	RESEARCH METHODOLOGY & IPR	General Course	2	0	0	2

Preamble:

This course introduces the strategies and methods related to scientific research. The students are also trained in the oral presentation with visual aids and writing technical thesis/reports/research papers. The salient aspects of publication and patenting along with the crucial role of ethics in research is discussed.

Course Outcomes

After the completion of the course the student will be able to

CO 1	Approach research projects with enthusiasm and creativity.
CO 2	Conduct literature survey and define research problem
CO 3	Adopt suitable methodologies for solution of the problem
CO 4	Deliver well-structured technical presentations and write technical reports.
CO 5	Publish/Patent research outcome.

Mapping of course outcomes with program outcomes

	PO 1	PO 2	PO 3	PO 4	PO 5	PO 6	PO 7
CO 1	<input checked="" type="checkbox"/>	<input checked="" type="checkbox"/>				<input checked="" type="checkbox"/>	
CO 2	<input checked="" type="checkbox"/>	<input checked="" type="checkbox"/>				<input checked="" type="checkbox"/>	
CO 3	<input checked="" type="checkbox"/>	<input checked="" type="checkbox"/>				<input checked="" type="checkbox"/>	
CO 4	<input checked="" type="checkbox"/>	<input checked="" type="checkbox"/>				<input checked="" type="checkbox"/>	
CO 5	<input checked="" type="checkbox"/>	<input checked="" type="checkbox"/>				<input checked="" type="checkbox"/>	
CO 6	<input checked="" type="checkbox"/>	<input checked="" type="checkbox"/>				<input checked="" type="checkbox"/>	

Assessment Pattern

Bloom's Category	End Semester Examination
Apply	70 %
Analyse	30 %
Evaluate	
Create	

Mark distribution

Total Marks	CIE	ESE	ESE Duration
100	40	60	2.5 hours

Continuous Internal Evaluation Pattern:

Course based task: 15 marks

Some sample course based tasks that can be performed by the student given below.

- *Conduct a group discussion based on the good practices in research.*
- *Conduct literature survey on a suitable research topic and prepare a report based on this.*

Seminar: 15 marks

Test paper: 10 marks

End Semester Examination Pattern:

Total Marks: 60

The examination will be conducted by the respective college with the question provided by the University. The examination will be for 150 minutes and contain two parts; Part A and Part B. Part A will contain 6 short answer questions with 1 question each from modules 1 to 4, and 2 questions from module 5. Each question carries 5 marks. Part B will contain only 1 question based on a research article from the respective discipline and carries 30 marks. The students are to answer the questions based on that research article.

Model Question paper

QP Code:		Total Pages:
Reg No.: _____		Name: _____
APJ ABDUL KALAM TECHNOLOGICAL UNIVERSITY		
FIRST SEMESTER M. TECH DEGREE EXAMINATION, Month & Year		
Course Code: 221RGE100		
Course Name: RESEARCH METHODOLOGY & IPR		
Max. Marks: 60		Duration: 2.5 Hours
PART A		
	Answer all questions. Each question carries 5 marks	Marks
1	Discuss the salient recommendations for great research recommended by Richard Hamming in his famous talk “You and Your Research”	30
2	What are the characteristics of a good research question? Discuss with an example.	
3	Explain the difference between continuum, meso-scale and micro scale approaches for numerical simulation.	
4	Discuss any four rules of scientific writing.	
5	What are the requirements for patentability?	
6	What are the differences between copyright and trademark protection?	
	Read the given research paper and write a report that addresses the following issues (The paper given can be specific to the discipline concerned)	
7	What is the main research problem addressed?	3
8	Identify the type of research	3
9	Discuss the short comings in literature review if any?	6
10	Discuss appropriateness of the methodology used for the study	6
11	Discuss the significance of the study and summarize the important results and contributions by the authors	6
12	Identify limitations of the article if any.	6

Syllabus and Course Plan

No	Topic	No. of Lectures
1	Introduction	
1.1	Meaning and significance of research, Skills, habits and attitudes for research, Types of research,	1
1.2	Characteristics of good research, Research process	1
1.3	Motivation for research: Motivational talks on research: "You and Your Research"- Richard Hamming	1
1.4	Thinking skills: Levels and styles of thinking, common-sense and scientific thinking, examples, logical thinking, division into sub-problems, verbalization and awareness of scale.	1
1.5	Creativity: Some definitions, illustrations from day to day life, intelligence versus creativity, creative process, requirements for creativity	1
2	Literature survey and Problem definition	
2.1	Information gathering – reading, searching and documentation, types of literature.	1
2.2	Integration of research literature and identification of research gaps	1
2.3	Attributes and sources of research problems, problem formulation, Research question, multiple approaches to a problem	1
2.4	Problem solving strategies – reformulation or rephrasing, techniques of representation, Importance of graphical representation, examples.	1
2.5	Analytical and analogical reasoning, examples, Creative problem solving using Triz, Prescriptions for developing creativity and problem solving.	1
3	Experimental and modelling skills	
3.1	Scientific method, role of hypothesis in experiment, units and dimensions, dependent and independent variables, control in experiment	1
3.2	precision and accuracy, need for precision, definition, detection, estimation and reduction of random errors, statistical treatment of data, definition, detection and elimination of systematic errors,	1
3.3	Design of experiments, experimental logic, documentation	1

3.4	Types of models, stages in modelling, curve fitting, the role of approximations, problem representation, logical reasoning, mathematical skills.	1
3.5	Continuum/meso/micro scale approaches for numerical simulation, Two case studies illustrating experimental and modelling skills.	1
4	Effective communication - oral and written	
4.1	Examples illustrating the importance of effective communication, stages and dimensions of a communication process.	1
4.2	Oral communication –verbal and non-verbal, casual, formal and informal communication, interactive communication, listening, form, content and delivery, various contexts for speaking- conference, seminar etc.	1
4.3	Guidelines for preparation of good presentation slides.	1
4.4	Written communication – Rules of scientific writing, form, content and language, layout, typography and illustrations, nomenclature, reference and citation styles, contexts for writing – paper, thesis, reports etc. Tools for document preparation-LaTeX.	1
4.5	Common errors in typing and documentation	1
5	Publication and Patents	
5.1	Relative importance of various forms of publication, Choice of journal and reviewing process, Stages in the realization of a paper.	1
5.2	Research metrics-Journal level, Article level and Author level, Plagiarism and research ethics	1
5.3	Introduction to IPR, Concepts of IPR, Types of IPR	1
5.4	Common rules of IPR practices, Types and Features of IPR Agreement, Trademark	1
5.5	Patents- Concept, Objectives and benefits, features, Patent process – steps and procedures	2

Reference Books

1. E. M. Phillips and D. S. Pugh, "How to get a PhD - a handbook for PhD students and their supervisors", Viva books Pvt Ltd.
2. G. L. Squires, "Practical physics", Cambridge University Press
3. Antony Wilson, Jane Gregory, Steve Miller, Shirley Earl, Handbook of Science Communication, Overseas Press India Pvt Ltd, New Delhi, 1st edition 2005
4. C. R. Kothari, Research Methodology, New Age International, 2004
5. Panneerselvam, Research Methodology, Prentice Hall of India, New Delhi, 2012.

6. Leedy P. D., Practical Research: Planning and Design, McMillan Publishing Co.
7. Day R. A., How to Write and Publish a Scientific Paper, Cambridge University Press, 1989.
8. William Strunk Jr., Elements of Style, Fingerprint Publishing, 2020
9. Peter Medawar, 'Advice to Young Scientist', Alfred P. Sloan Foundation Series, 1979.
10. E. O. Wilson, Letters to a Young Scientist, Liveright, 2014.
11. R. Hamming, You and Your Research, 1986 Talk at Bell Labs.

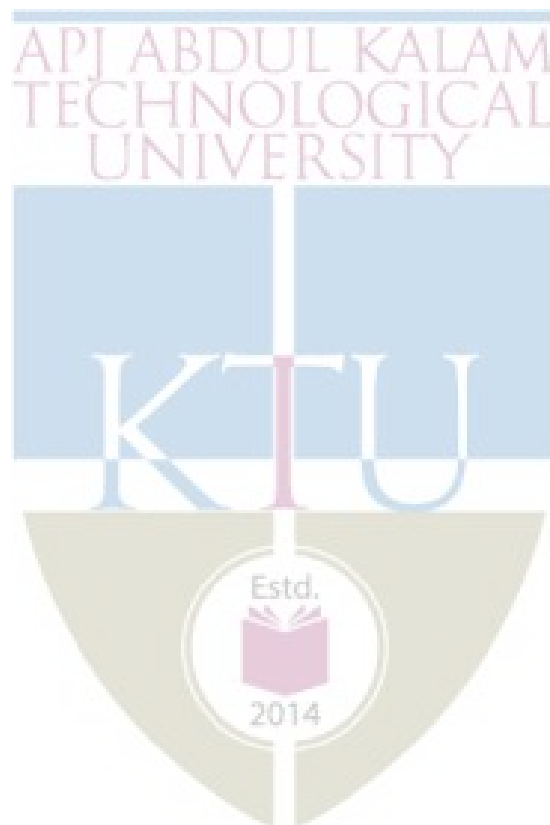

APJ ABDUL KALAM
TECHNOLOGICAL
UNIVERSITY

SEMESTER II

KTU

Estd.



2014

Discipline: CIVIL ENGINEERING

Stream : CE4

CODE	COURSE NAME	CATEGORY	L	T	P	CREDIT
222TCE100	ADVANCED NUMERICAL METHODS	DISCIPLINE CORE 2	3	0	0	3

Preamble: For solving complex problems in mechanics and engineering, a post-graduate student must be well versed in numerical methods along with skills to apply them. This course equips the student with various numerical techniques that finds applications in civil engineering, across various streams (specialisations). Special focus is given to finite element method, explaining the relevance, versatility and fundamental concepts of this numerical tool.

Course Outcomes: After the completion of the course, the student will be able to

CO 1	Obtain the solution of simultaneous Linear system of equations
CO 2	Obtain the numerical solutions of ordinary differential equations
CO 3	Obtain the numerical solutions for solving boundary value problems of partial differential equations
CO 4	Describe the terminologies, applications or procedure of finite element method
CO 5	Describe or apply the concept of finite element method

Mapping of course outcomes with program outcomes

	PO 1	PO 2	PO 3	PO 4	PO 5	PO 6	PO 7
CO 1	3			3			
CO 2	3			3			
CO 3	3			3			
CO 4	1		2	2	2	2	
CO 5	3			2	2	2	

(1-Weak, 2-Medium, 3- strong)

Assessment Pattern

Bloom's Category	End Semester Examination
Apply	25
Analyse	25
Evaluate	5
Create	5

Mark distribution

Total Marks	CIE	ESE	ESE Duration
100	40	60	2.5 hours

Continuous Internal Evaluation Pattern: 40 marks

Preparing a review article based on peer reviewed original publications (Minimum 10 publications shall be referred): 15 marks

Course based task/Seminar/Data collection and interpretation : 15 marks

Test paper, 1 no. : 10 marks

Test paper shall include minimum 80% of the syllabus.

Note: Enough opportunity to explore the practical examples from specialization should be given to the students. One assignment/course project should be based on the coding or use of packages

End Semester Examination Pattern: 60 marks

The end semester examination will be conducted by the University. There will be two parts; Part A and Part B. Part A will contain 5 numerical/short answer questions with 1 question from each module, having 5 marks for each question (such questions shall be useful in the testing of knowledge, skills, comprehension, application, analysis, synthesis, evaluation and understanding of the students). Students should answer all questions. Part B will contain 7 questions (such questions shall be useful in the testing of overall achievement and maturity of the students in a course, through long answer questions relating to theoretical/practical knowledge, derivations, problem solving and quantitative evaluation), with minimum one question from each module of which student should answer any five. Each question can carry 7 marks.



QP CODE:

Reg No.: _____

Name: _____

**APJ ABDUL KALAM TECHNOLOGICAL UNIVERSITY FIRST SEMESTER
M.TECH. DEGREE EXAMINATION, MONTH & YEAR**

Course Code: XXXXXX

ADVANCED NUMERICAL METHODS

Max. Marks: 60

Duration: 2.5 hours

PART A

(Answer **ALL** questions; each question carries 5 marks)

1. Explain the procedure of solution of Tridiagonal systems
2. Explain single shooting method for solving Boundary value problems
3. Explain the parabolic and elliptic partial differential equations with examples
4. Explain any five practical applications of Finite element in the con
5. Explain Generalised coordinates and Natural coordinates in Finite Element analysis

PART B

(Answer **any FIVE** questions; each question carries 7 marks)

6. Solve the system of equations by Jacobi's iteration considering initial approximation as $[0.5, -0.5, 0.5]^T$

$$4x_1 + x_2 + x_3 = 2$$

$$x_1 + 5x_2 + 2x_3 = -6$$

$$x_1 + 2x_2 + 3x_3 = -4$$

7. Solve $y' = x^2 + y$ for $y=0.1$, given that $y(0)=1$ considering $h=0.05$ using (i) Eulers method and (ii) Runge Kutta method
8. Solve the equation $uxx + uyy = 0$ for the square mesh with boundary value as shown in figure

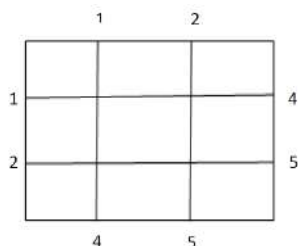

- CIVIL ENGINEERING-CE4
9. Solve $\left(\frac{\partial u}{\partial t}\right) = \left(\frac{\partial^2 u}{\partial x^2}\right)$ subject to the conditions $u(x,0) = \sin(\pi x)$ for $0 \leq x \leq 1$ $u(0, t) = u(1, t) = 0$. Perform the computations of two levels taking $h=1/3$ and $t=1/36$ using Crank Nicolson implicit scheme
10. Explain in detail the steps of finite element analysis
11. Explain forms of shape functions in finite element analysis
12. Explain the convergence criteria in finite element applications in detail

Syllabus

Module 1

(7 hours)

Solutions of simultaneous Linear Systems of Equations- Solution of linear systems – Direct methods, Gauss-Jordan Method-Method of factorization- Solution of Tridiagonal Systems. Solution by matrix decomposition Iterative methods: Jacobi, Gauss-Siedel iteration for ordinary and sparse systems, Convergence of iterative solution schemes with examples.

Module 2

(7 hours)

Solving Ordinary Differential Equations- The Elementary Theory of Initial-Value Problems -Euler's Method- Higher-Order Taylor Methods. Runge-Kutta Method- Introduction to solution methods for differential algebraic equations- Single shooting method for solving ODE-BVPs.

Module 3

(7 hours)

Partial differential equations in two dimensions- Parabolic equations- Explicit finite difference method. Crank-Nicholson implicit method - Ellipse equations- Finite difference method-Problems with irregular boundaries.

Module 4

(7 hours)

Introduction to Finite Element Method – Historical Background — Mathematical Modeling of field problems in Engineering — Governing Equations — Discrete and continuous models — Boundary, Initial and Eigen Value problems– Basic concepts of the Finite Element Method- Displacement approach-Concept of Stiffness Matrix and Boundary Condition-- General procedure of FEA

Module5

(7 hours)

Concept of Finite Element Method- Concept of Nodes, elements, Generalised coordinates and Natural coordinates in FEA. Shape functions – Polynomials - Lagrangian and Hermitian Interpolation -- Compatibility - C0 and C1 elements - Convergence criteria - Conforming & nonconforming elements. Development of element matrices for one dimensional elements.

Text Books

1. Gupta, S.K. Numerical Methods for Engineers. Wiley Eastern, New Delhi, 1995.
2. Cook, R.D. Concepts and Applications of Finite Element Analysis, Wiley.

Reference Books

1. Gilbert Strang, Linear Algebra and its Applications (4th Ed.), Wellesley Cambridge Press 2009
2. Gourdin, A. and M Boumhrat. Applied Numerical Methods. Prentice Hall India, New Delhi 2000
3. Chopra S.C. and Canale R.P. Numerical Methods for Engineers, McGraw Hill 2006
4. Krishnamoorthy C S, *Finite Element Analysis- Theory and Programming*, Tata McGraw Hill, New Delhi., 1994
5. Rao, S.S. Finite Element Analysis, Elsevier Butterworth-Heinemann
6. Gerald and Wheatly, *Applied Numerical Analysis*, Pearson Education.
7. Rajasekharan S., *Numerical Methods in Science and Engineering*, S Chand & Company, 2003.
8. Bathe K J, *Finite Element Procedures in Engineering Analysis*, Prentice Hall, New Delhi. 1982
9. Chandrupatla T R and Belegundu A D, *Introduction to Finite Elements in Engineering*, Pearson Education, New Delhi 1998
10. Rajasekharan S, *Finite Element Analysis in Engineering Design*, Wheeler, New Delhi
11. Hutton D V, *Fundamentals of Finite Element Analysis*, Tata McGraw Hill Education Private Ltd, New Delhi

CODE	COURSE NAME	CATEGORY	L	T	P	CREDIT
222TCE103	FINITE ELEMENT METHOD	PROGRAM CORE 3	3	0	0	3

Preamble: Nil

Course Outcomes: After the completion of the course the student will be able to

CO 1	Develop approximate solution to boundary value problems in structural mechanics using method of weighted residuals and variational methods.
CO 2	Develop field approximations for various one- and two-dimensional finite elements.
CO 3	Formulate element equilibrium equations for 1D and 2D finite elements for solution of structural mechanics problems using energy principles.
CO 4	Understand the computational techniques for numerical integrations, large system of equation solvers etc. and apply the same for implementation of finite element method.

Mapping of course outcomes with program outcomes

	PO 1	PO 2	PO 3	PO 4	PO 5	PO 6	PO 7
CO 1	3	2	3	3	3	3	1
CO 2	3	2	3	3	3	3	1
CO 3	3	2	3	3	3	3	1
CO 4	3	2	3	3	3	3	1

Assessment Pattern

Bloom's Category	Continuous Assessment test	End Semester Examination
Understand	10	15
Apply	10	15
Analyse	20	30
Evaluate	-	-
Create	-	-

Mark distribution

Total Marks	CIE	ESE	ESE Duration
100	40	60	2.5 hours

Continuous Internal Evaluation Pattern:

Continuous Internal Evaluation: 40 marks Micro project/Course based project : 20 marks

Course based task/Seminar/Quiz : 10 marks

CIVIL ENGINEERING-CE4

Test paper, 1 no. : 10 marks

The project shall be done individually. Group projects not permitted. Test paper shall include minimum 80% of the syllabus.

End Semester Examination Pattern:

The end semester examination will be conducted by the University. There will be two parts; Part A and Part B. Part A contain 5 numerical questions (such questions shall be useful in the testing of knowledge, skills, comprehension, application, analysis, synthesis, evaluation and understanding of the students), with 1 question from each module, having 5 marks for each question. Students shall answer all questions. Part B contains 7 questions (such questions shall be useful in the testing of overall achievement and maturity of the students in a course, through long answer questions relating to theoretical/practical knowledge, derivations, problem solving and quantitative evaluation), with minimum one question from each module of which student shall answer any five. Each question can carry 7 marks. Total duration of the examination will be 150 minutes.

Model Question Paper

Max. Marks: 60

Duration: 2.5 Hours

PART A

Answer all questions; each question carries 5 marks

1. The stress components at a point in a body are given by

$$\sigma_x = 2xy^2z + 2x; \sigma_y = 5xyz + 3y; \sigma_z = x^2y + y^2z; \tau_{xy} = 0; \tau_{yz} = \tau_{xz} = 2xy^2z + 2xy$$

Check whether these stress components satisfy the conditions of equilibrium or not at the point (1,-1,2). If not, determine the suitable body force components required at this point so that the stress components satisfy equilibrium.

2. What are conforming and non-conforming elements? Briefly explain the convergence characteristics of both.
3. Starting from the Hermitian shape functions develop the consistent load vector for a two node 1D beam element subjected to a uniformly distributed of intensity w covering full span.
4. Evaluate the following integrals using two point Gauss quadrature.

(i) $\int_{-1}^1 \int_{-1}^1 xy \, dx dy$

(ii) $\int_1^3 \frac{dx}{(x^4 + 1)^{1/2}}$

5. Write short notes on:

- (i) Shear locking (ii) Storage schemes in FEA

PART B

Answer any five questions; each question carries 7 marks

6. Using modified Galerkin method obtain an approximate solution of the following boundary value problem

$$2u''(x) + 3u(x) = 0, \quad 1 < x < 3$$

$$u(1) = 1 \quad \text{Essential boundary condition}$$

$$u'(3) = 1 \quad \text{Natural boundary condition}$$

Assume a quadratic polynomial satisfying the essential boundary condition as a trial solution.

7. A two-member truss is loaded as shown in Fig.2. The area of cross section of each element is 500 mm² and E = 200 GPa. Compute the displacement components at node 3, reactions at supports and member stresses

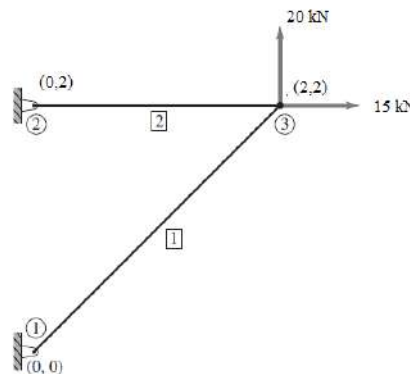

Fig. 2

8. The nodal displacement components (in mm units) of a triangular element from the finite element analysis of a thin plate is shown in Fig.3. Develop appropriate approximations for the u and v fields within the element in terms of area coordinates .

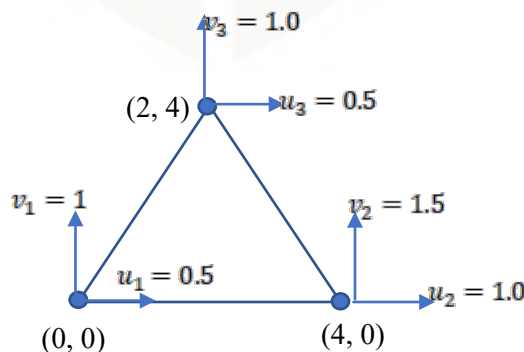

Fig.3.

9. (i) Differentiate between Lagrangian and Hermitian interpolation. (2 marks)
- (ii) Compute the consistent nodal load vector when a surface traction of uniform intensity w N/m length acts normal to the edge containing nodes with coordinates (4,0) and (2,4) of the triangular element shown in Fig.3. (5 marks)
10. Develop the FE formulation for an isoparametric 4 node quadratic element for solution of 2D elasticity problems.
11. Develop the Finite element formulation for a Resinner-Mindlin plate element.
12. Write short notes on:
- (i) Spurious energy modes. (4 marks)
- (ii) Frontal solver in FEA. (3 marks)

Syllabus and Course Plan

No	Topic	No. of Lectures
1	Module I: Classical approximate solution of boundary value problems & Introduction to FEA	
1.1	Idealization of physical problems & mathematical modelling;	1
1.2	Basic equations of elasticity: Equilibrium, traction boundary conditions, Strain – Displacement relations — Constitutive relations; 2D idealization – Plane stress & Plane strain conditions	1
1.3	Approximate solution of boundary value problems – method of least squares,	1
1.4	Approximate solution of BVP-Weighted residual methods- structural mechanics applications.	2
1.5	Approximate solution of BVP -Variational approach (Rayleigh-Ritz method)- structural mechanics applications.	2
1.6	Introduction to Finite Element Method – History of development – Advantages – Disadvantages - General description of the method.	1
2	Module II: Review of direct stiffness method & field approximations in FEA	
2.1	Direct stiffness method – Review of basic concepts of matrix displacement analysis – formulation element stiffness matrices and load vectors for truss & beam	2

	elements	
2.2	Coordinate transformations, global assembly, global equilibrium solution, estimation of element forces.	2
2.3	Field approximation in FEA: Polynomial approximations - Convergence & Compatibility requirements	1
2.4	Polynomial approximation for 1D & 2D fields in global coordinates; continuity requirements.	1
2.5	1D & 2D Field approximation using Lagrange polynomials	1
2.6	Area coordinates and field approximation for CST & LST elements	1
2.7	Shape functions for serendipity elements	1
3	Module III: Formulation of element equations	
3.1	Development of equilibrium equations for finite elements- using principle of virtual work	1
3.2	Formulation of element equations (including consistent load vector) for 1D bar element for modelling axial behaviour.	1
3.3	Formulation of element equations (including consistent load vector) for 1D beam (Euler-Bernoulli) element for modelling flexural behaviour	2
3.4	Formulation of element equations (including consistent load vector) for CST element for modelling plane stress/strain problems	2
3.5	Formulation of LST & 4 node quadrilateral elements for modelling plane stress/strain problems	1
4	Module IV: Isoparametric formulations & Numerical Integrations	
4.1	Geometric approximation – concept of mapping – Isoparametric, sub-parametric and super-parametric mapping. Isoparametric Mapping/formulations for 1D line elements	2
4.2	Isoparametric mapping for planar bilinear elements; formulation of element equations for four node isoparametric quadrilateral element	2
4.3	Restrictions in mapping	1
4.4	Numerical integrations – introduction to Newton-Cotes and Gauss quadrature - Gauss quadrature formulae for 1D integration	2
4.5	Gauss quadrature formulae for 2D	1
5	Module V: Plate elements, Storage & solution schemes for large system of equations	
5.1	Introduction to plate bending – Kirchoff and Mindlin plate theories	2
5.2	FE formulations for Kirchoff and Mindlin Plate elements;	2
5.3	Shear locking, reduced and selective reduced integrations; Spurious energy modes;	1
5.4	Global assembly of element equations; Storage schemes in FEA – Banded and Skyline storage; Calculation of semi-band width – node numbering for optimal bandwidth	2
5.5	Solution schemes in FEA – Frontal solver; Discussion of modelling and analysis using recent commercial finite	1

Reference Books

1. Cook R D et al., *Concepts and Applications of Finite Element Analysis*, John Wiley & Sons, Singapore.
2. Logan D L, *A First Course in Element Method*, Thomson, 2007.
3. M. Asghar Bhatti, *Fundamentals of Finite Element Analysis and Applications*, John Wiley & Sons New Jersey, U.S.
4. J.N. Reddy, *An Introduction to Finite Element Method*, Tata McGraw Hill Publishing Company Ltd., New Delhi.
5. Hutton D V, *Fundamentals of Finite Element Analysis*, Tata McGraw Hill Education Private Ltd. New Delhi.
6. Krishnamoorthy C S, *Finite Element Analysis- Theory and Programming*, Tata McGraw Hill, New Delhi
7. Rajasekharan S, *Finite Element Analysis in Engineering Design*, Wheeler, New Delhi
8. Chandrupatla T R and Belegundu A D, *Introduction to Finite Elements in Engineering*, Pearson Education, New Delhi
9. Bathe K J, *Finite Element Procedures in Engineering Analysis*, Prentice Hall, New Delhi
10. Zienkiewicz O C and Taylor R W., *Finite Element Method*, Elsevier Butterworth-Heinemann, UK

COURSE CODE	COURSE NAME	CATEGORY	L	T	P	CREDIT
222PCE100	MINI PROJECT	PROJECT	0	0	4	2

Mini project can help to strengthen the understanding of student's fundamentals through application of theoretical concepts and to boost their skills and widen the horizon of their thinking. The ultimate aim of an engineering student is to resolve a problem by applying theoretical knowledge. Doing more projects increases problem solving skills.

The introduction of mini projects ensures preparedness of students to undertake dissertation. Students should identify a topic of interest in consultation with PG Programme Coordinator that should lead to their dissertation/research project. Demonstrate the novelty of the project through the results and outputs. The progress of the mini project is evaluated based on three reviews, two interim reviews and a final review. A report is required at the end of the semester.

Evaluation Committee - Programme Coordinator, One Senior Professor and Guide.

Sl. No	Type of evaluations	Mark	Evaluation criteria
1	Interim evaluation 1	20	
2	Interim evaluation 2	20	
3	Final evaluation by a Committee	35	Will be evaluating the level of completion and demonstration of functionality/ specifications, clarity of presentation, oral examination, work knowledge and involvement
4	Report	15	the committee will be evaluating for the technical content, adequacy of references, templates followed and permitted plagiarism level(not more than 25%)
5	Supervisor/Guide	10	
Total Marks		100	

CODE	COURSE NAME	CATEGORY	L	T	P	CREDIT
222LCE003	COMPUTATIONAL LAB	LABORATORY	0	0	2	1

Preamble: The course is intended to provide the students with an ability to model, analyse and interpret results by analysing and design various structural elements/whole structure using software packages such as SAP2000, ETABS, STAAD, ANSYS, ABAQUS, MATLAB, MATHCAD, MATHEMATICA, MS-EXCEL, MIDAS CIVIL, CSI BRIDGE, TEKLA, AUTOCAD, REVIT and. It also encompasses to develop a firm foundation for research and practice in Structural Engineering. It also enables students to familiarize with industry standards projects with the help of cutting-edge technology and software available in the field at present to have no gap between academia and industry. All design and detailing shall be done as per the latest BIS, IRC and other relevant Codes of Practice.

Course Outcomes: After the completion of the course on Computational Lab, the student will be able to:

CO 1	Model structural elements/ whole structures using finite element packages.
CO 2	Analyse and design structural elements/ whole structures using finite element packages.
CO 3	Interpret results from finite element analysis packages.
CO 4	Draw structural details using AutoCAD.
CO 5	Write design reports.
CO 6	Develop bar bending schedule and bill of quantities from the structural drawings.

Mapping of course outcomes with program outcomes

	PO 1	PO 2	PO 3	PO 4	PO 5	PO 6	PO 7
CO 1	2	3	3	2	2	2	1
CO 2	2	3	3	2	2	2	1
CO 3	3	3	3	3	2	2	1
CO 4	2	3	3	2	2	2	1
CO 5	2	3	3	2	2	2	3
CO 6	2	3	3	2	2	2	3

Mark distribution

Total Marks	CIE	ESE	ESE Duration
100	100	–	–

Continuous Internal Evaluation Pattern:

The laboratory courses will be having only Continuous Internal Evaluation and carries 100 marks. Final assessment shall be done by two examiners; one examiner will be a senior faculty from the same department.

Syllabus and Course Plan**Concrete Structures**

Analysis, design and detailing of a G + 10 residential building – Analysis, design and detailing of an overhead circular and rectangular water tanks with staging – Analysis, design and detailing of a ribbed slab floor system–Analysis, design and detailing of shear walls –Application of strut-and-tie method to design and detail various RC elements and junctions – Develop a spreadsheet for generation of interaction curves for RC rectangular columns– Design of slab bridge.

Steel Structures

Design of Steel Industrial Building –Design of Steel Multi-storey Building.

List of Experiments

Expt. No.	Title	Hours Allotted
1	Analysis, design and detailing of a G + 10 residential building without shear wall.	2
2	Analysis, design and detailing of an overhead circular water tank with staging.	2
3	Analysis, design and detailing of an overhead rectangular water tank with staging using LSM and IS	2
4	Analysis, design and detailing of a ribbed slab floor system.	2
5	Analysis, design and detailing of a G + 10 residential building with shear wall.	2
6	Using strut-and-tie method, design and detail various RC elements and beam-column joints.	2
7	Develop a spreadsheet for generation of interaction curves for RC rectangular columns.	2
8	Design and detail a simply supported slab bridge of spans less than or equal to 6 m.	2
9	Design and detail a Multi-storey Steel Building.	2
10	Design and detail a Steel industrial building.	2
11	Design and detail a single span, straight RC Slab bridge.	2

Reference Books/Resources:

1. Manuals of SAP2000, ETABS, STAAD, ANSYS, MATLAB, MATHCAD, MATHEMATICA, MS-EXCEL, MIDAS CIVIL, CSI BRIDGE, TEKLA, AUTOCAD, REVIT and ABAQUS.
2. IS 456:2000, "PLAIN AND REINFORCED CONCRETE - CODE OF PRACTICE", Bureau of Indian Standards New Delhi.
3. IS800:2007, "GENERAL CONSTRUCTION IN STEEL - CODE OF PRACTICE", Bureau of Indian Standards New Delhi.
4. IS 3370 (Part 1 to 4), "Concrete Structures for Retaining Aqueous Liquids - Code of Practice", Bureau of Indian Standards New Delhi.
5. IS 1893 (Part 1 to 6), "Criteria for Earthquake Resistant Design of Structures", Bureau of Indian Standards New Delhi.
6. IRC:112-2020, "Code of Practice for Concrete Road Bridges", Indian Roads Congress New Delhi.
7. V. L. Shah and S. R. Karve, "Illustrated Design of Reinforced Concrete Buildings", Assorted Editorial.

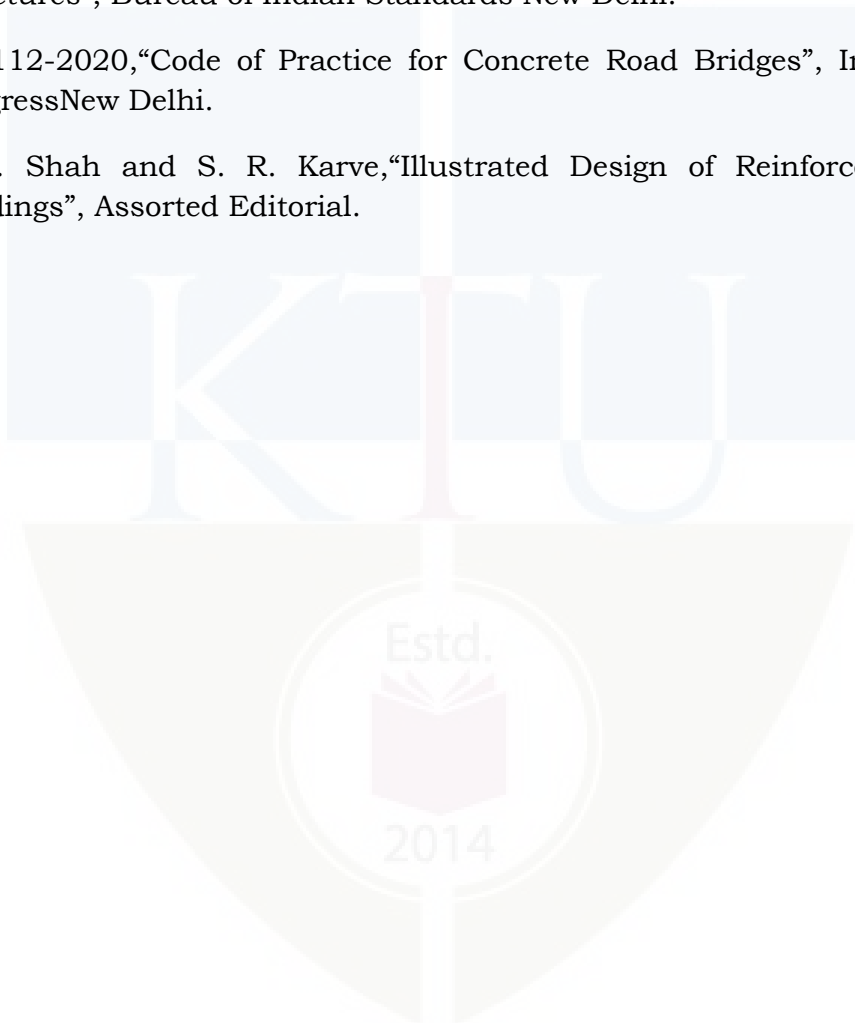

APJ ABDUL KALAM
TECHNOLOGICAL
UNIVERSITY

SEMESTER II

PROGRAM ELECTIVE III

Estd.



2014

CODE	COURSE NAME	CATEGORY	L	T	P	CREDIT
222ECE036	STRUCTURAL HEALTH MONITORING	PROGRAMME ELECTIVE 3	3	0	0	3

Preamble: This subject is taught to impart knowledge about the Structural Health Monitoring Concepts. Diagnosis the distress in the structure by understanding the causes and factors. Assess the health of structure using static field methods and dynamic field tests. Suggest repairs and rehabilitation measures of the structure

Course Outcomes: The COs shown are only indicative. For each course, there can be 4 to 6 COs.

After the completion of the course the student will be able to

CO 1	Know the causes of Distress in structures, factors effecting structural health, need of regular maintenance of structures
CO 2	Understand the concept of structural health monitoring and various methods applied for monitoring of structures and structural safety
CO 3	Understand the importance of structural audit and Assessment of Health Structure, Collapse and Investigation, Investigation Management, SHM Procedures
CO 4	Know The Importance of Static field testing, Types of Static Tests, Simulation and Loading Methods, sensor systems and hardware requirements, Static Response Measurement
CO 5	Understand the Dynamic Field testing, stress History Data, Dynamic Response Methods, Hardware for Remote Data Acquisition systems, Remote Structural Health Monitoring.
CO 6	Introduction to Repairs and Rehabilitations of Structures impedance (EMI) technique, Adaptations of EMI technique

Mapping of course outcomes with program outcomes

	PO 1	PO 2	PO 3	PO 4	PO 5	PO 6	PO 7
CO 1	3	-	-	-	1	-	-
CO 2	-	-	-	1	2	-	-
CO 3	3	-	-	1	2	-	-
CO 4	-	-	-	-	1	-	-
CO 5	-	-	-	-	1	-	-
CO 6	-	2	-	-	2	-	-

Assessment Pattern

Bloom's Category	Continuous Assessment test	End Semester Examination
Remember	10	15
Understand	20	30
Apply	10	15
Create		

Mark distribution

Total Marks	CIE	ESE	ESE Duration
100	40	60	2.5 hours

Continuous Internal Evaluation Pattern:

Continuous Internal Evaluation: 40 marks Micro project/Course based project : 20 marks

Course based task/Seminar/Quiz : 10 marks

Test paper, 1 no. : 10 marks

The project shall be done individually. Group projects not permitted. Test paper shall include minimum 80% of the syllabus.

End Semester Examination Pattern:

The end semester examination will be conducted by the University. There will be two parts, Part A and Part B. Part A contains 5 numerical questions (such questions shall be useful in the testing of knowledge, skills, comprehension, application, analysis, synthesis, evaluation and understanding of the students), with 1 question from each module, having 5 marks for each question. Students shall answer all questions. Part B contains 7 questions (such questions shall be useful in the testing of overall achievement and maturity of the students in a course, through long answer questions relating to theoretical/practical knowledge, derivations, problem solving and quantitative evaluation), with minimum one question from each module of which student shall answer any five. Each question can carry 7 marks. Total duration of the examination will be 150 minutes.

Course Level Assessment Questions

Course Outcome 1 (CO1):

1. State the factors affecting Health of Structures
2. Write short notes on division of maintenance.
3. Define distress
4. Name different types of distress
5. What do you mean by deterioration? Explain the mechanism of deterioration in concrete structures?
6. Discuss in detail various construction stage defects & their preventive measures?
7. Explain preventive maintenance of structures? Explain them in detail

8. Write the different reasons for development of cracks due to errors in design and detailing. Give preventive measures.

Course Outcome 2 (CO2)

1. Define the concept of health monitoring of structures
2. Explain the working system of components of structural health monitoring in detail.
3. Explain Active and Passive Smart Materials
4. What are SHM Technologies? Explain briefly.
5. Enumerate the dynamic response analysis using Laser Doppler Vibrometer
6. What are the challenges in Implementation of SHM

Course Outcome 3(CO3):

1. What are the importance and need of Non-Destructive Testing
2. Basic Methods for NDT of Concrete Structures. Explain
3. What are quality control tests
4. Explain fundamental principle of partial destructive tests
5. Visual Inspection Test
6. Schmidt Rebound Hammer Test

Course Outcome 4 (CO4):

1. Explain the different Types of Static Tests in detail.
2. Discuss Simulation and Loading Methods in static structural health monitoring.
3. Explain the role of sensor systems in static structural health monitoring.
4. What are the functions of hardware tools in static structural health monitoring?
5. Explain about Static Response Measurement
6. Explain long-Term static structural health monitoring?
7. What is seismic structural health monitoring?
8. Write short notes on intelligent structural health monitoring?
9. List out the applications of structural health monitoring in post-earthquake controls.
10. What are smart materials and explain their applications in structural health monitoring

Course Outcome 5 (CO5):

CIVIL ENGINEERING-CE4

1. Explain the application and Adaptations of EMI technique in structural health monitoring.
2. Write a short notes on data based techniques in vibration based structural health monitoring.
3. Define and explain in detail about electro-mechanical impedance (EMI) technique
4. Explain the procedure for Adaptations of EMI technique.
5. Name the types of Dynamic Field Test
6. What is vibration based structural health monitoring.
7. State the different forms of Dynamic Response Methods
8. What is Dynamic Response Method remember
9. Name different types of sensors used in structural health monitoring
10. Define epoxy resins.

Course Outcome 6 (CO6):

1. Define repair in a structure
2. Discuss the method of underpinning in detail.
3. Discuss the various types of blanket repair techniques.
4. Enumerate the different methods available for repairs of concrete works. Discuss the any one in detail.

Estd.



2014

Model Question Paper

Time 2.5 hrs

Maximum: 60marks

PART A

Answer all questions; each question carries 5 marks

1. What is the structural health monitoring? Explain scope of structural health monitoring?
2. Explain the role of piezoelectric sensors in structural health monitoring
3. Fundamental Principle of Partial Destructive Tests
4. What are the pros and cons of static structural health monitoring system
5. Explain about Electrical-Mechanical Impedance (EMI) Method?

PART B

Answer any five questions; each question carries 7 marks

6. What is distress? Give its classification.
7. Explain the Role of Smart Materials in Structural Health Monitoring System and Discuss about Active and Passive Smart Materials?
8. Explain in detail assessment of a health of a structure by NDT's equipment.
9. Describe the procedure of behavioral test and its importance.
10. Explain stress history data of dynamic field testing
11. Enumerate the different methods available for repairs of concrete works. Discuss the any one in detail.
12. Explain the Process of Guniting in Detail With Figure.

Syllabus and Course Plan

No	Topic	No. of Lectures
1	Introduction to Structural Health Monitoring:	
1.1	Definition of Structural Health Monitoring SHM – Principle and Organization of a SHM System – SHM versus NDE – Advantages of SHM - Factors affecting Health of Structures	2hr
1.2	Repair and Rehabilitation - Facets of Maintenance – importance of Maintenance	1hr
1.3	Various aspects of Inspection - Assessment procedure for evaluating a damaged structure – causes of deterioration	1.5hr
2	Structural Health Monitoring :	
2.1	Concepts, Various Measures, Structural Safety in Alteration	1hr
2.2	Active and Passive Smart Materials – SHM Technologies – Piezoelectric Sensors – Magneto strictive Sensors – Optical Fibre Sensors	2hr
2.3	Dynamic Response Analysis using Laser Doppler Vibrometer – Challenges in Implementation of SHM	1hr
3	Structural Audit :	
3.1	Assessment of Health of Structure- Assessment by NDT equipment's	1hr
3.2	Introduction to NDT – Importance and Need of Non-Destructive Testing – Basic Methods for NDT of Concrete Structures – Testing of Concrete – Quality Control Tests	2hr
3.3	Partial Destructive Tests – Fundamental Principle – Equipment –General Procedure - Visual Inspection Test-Schmidt Rebound Hammer Test	2hr
3.4	Collapse and Investigation Management, SHM Procedures	1hr
4	Static Field Testing :	
4.1	Types of Static Tests, Static Testing- Static field testing- types of static tests loading methods	2hr
4.2	Behavioral/ Diagnostic tests - Proof tests -Static response measurement – strain gauges, LVDTs, dial gauges	2hr
4.3	Case study	2hr
5	Dynamic Field Testing and rehabilitation:	
5.1	Types of dynamic tests - Stress history data -Dynamic load allowance tests Ambient vibration tests – Forced Vibration Method - Dynamic response methods - Impact hammer testing- Shaker testing - Periodic and continuous monitoring	3hr
5.2	Introduction to Repairs and Rehabilitations of Structures:	3hr

	Repair of Structure – Common types of Repairs – Repair in Concrete Structures – Repairs in Under Water Structures – Guniting– Shot Create – Underpinning. Strengthening of Structures – Strengthening Methods – Retrofitting– Jacketing.	CIVIL ENGINEERING-CE4
5.3	Case Studies(Site Visits) electro mechanical impedance (EMI) technique, adaptations of EMI technique	1hr

Reference Books

1. Hua-Peng Chen, Structural Health Monitoring of Large Civil Engineering Structures ,John Wiley & Sons Ltd, Year: 2018
2. Douglas E Adams, Health Monitoring of Structural Materials and Component - Methods with Applications, John Wiley and Sons, 2007.
3. Bhattacharjee, Concrete Structures Repair Rehabilitation and Retrofitting, CBS; first edition (2019).
4. J. P. Ou, H. Li and Z. D. Duan, Taylor, Structural Health Monitoring and Intelligent Infrastructure, Vol1, and Francis Group, London, UK, 2006
5. Victor Giurgutiu, Structural Health Monitoring with Wafer Active Sensors, Academic Press Inc, 2007
6. Daniel Balageas, Claus Peter Fritzen, Alfredo Güemes, Structural Health Monitoring,John Wiley and Sons, 2006
7. Fu-Kuo, Chang Structural Health Monitoring: Current Status and Perspectives CRC Press; 1 edition (24 April 1998)
8. Structural Health Monitoring of Civil Infrastructure System, Vistasp M. Karbhari and Farhad Ansari, Wood Head Publishing Limited, Cambridge, 2009.

CODE	COURSE NAME	CATEGORY	L	T	P	CREDIT
222ECE037	DESIGN OF BRIDGES	PROGRAMME ELECTIVE 3	3	0	0	3

Preamble: The course aims to provide a basic understanding of the concepts and design of both concrete and steel bridges as per the latest Indian Road Congress (IRC) and Indian Railway Standard (IRS) specifications. The student is expected to independently plan, analyse, design, and detail various types and components of bridges after completion of this course. The students will be exposed through field visits (whenever feasible) to real-life bridge design and construction practices.

Course Outcomes: After the completion of the course on Design of Bridges, the student will be able to

CO 1	Review bridge specifications as per current IRC and IRS standards for bridges.
CO 2	Design and detail slab and T beam bridges.
CO 3	Design and detail box culvert and Prestressed Concrete bridges.
CO 4	Design and detail plate girder and composite bridges
CO 5	Design elastomeric bearings in bridges.
CO 6	Analyse substructures and foundations in bridges.

Mapping of course outcomes with program outcomes

	PO 1	PO 2	PO 3	PO 4	PO 5	PO 6	PO 7
CO 1	3	3	3	3	2	2	1
CO 2	3	3	3	3	2	2	1
CO 3	3	3	3	3	2	2	1
CO 4	3	3	3	3	2	2	1
CO 5	3	3	3	3	2	2	1
CO 6	3	3	3	3	2	2	1

Assessment Pattern

Bloom's Category	Continuous Evaluation (Marks)	End Semester Examination(Marks)
	Remember	10
Understand	10	15
Apply	15	25
Analyse	5	5
Evaluate	–	–
Create	–	–

Mark distribution

Total Marks	CIE	ESE	ESE Duration
100	40	60	2.5 hours

Continuous Internal Evaluation Pattern:

Preparing a review article based on peer reviewed original publications (minimum 10 publications shall be referred): 15 marks

Course based task/Seminar/Data collection and interpretation: 15 marks

Test paper, 1 no.: 10 marks

Test paper shall include minimum 80% of the syllabus.

End Semester Examination Pattern:

The end semester examination will be conducted by the respective College. There will be two parts; Part A and Part B. Part A will contain 5 numerical/short answer questions with 1 question from each module, having 5 marks for each question (such questions shall be useful in the testing of knowledge, skills, comprehension, application, analysis, synthesis, evaluation and understanding of the students). Students should answer all questions. Part B will contain 7 questions (such questions shall be useful in the testing of overall achievement and maturity of the students in a course, through long answer questions relating to theoretical/practical knowledge, derivations, problem solving and quantitative evaluation), with minimum one question from each module of which student should answer any five. Each question can carry 7 marks.

Note: The marks obtained for the ESE for an elective course shall not exceed 20% over the average ESE mark % for the core courses. ESE marks awarded to a student for each elective course shall be normalized accordingly. For example, if the average end semester mark % for a core course is 40, then the maximum eligible mark % for an elective course is $40+20 = 60\%$.

Model Question Paper**C****PART A****(Answer ALL questions)**

1. What are impact factors? How these factors vary with respect to the type of loading, span, and type of bridge?
2. List the live loads to be considered in the design of road bridges?
3. Explain the effective width procedure for finding moments due to concentrated loads acting on one-way slabs.
4. Explain Courbon's method of finding reaction factors in a T beam girder bridge using an example.
5. Sketch a single cell box culvert and mark the components.

PART B**(Answer Any FIVE questions only)**

6. (a) Explain the classification of bridges with sketches.
(b) Explain the importance of site investigation in bridge engineering.
12. Design an interior cross girder for a T beam bridge for the following data: Effective span = 16 m, Live load – IRC Class 70R tracked; Materials – M25 concrete and Fe 415 steel; spacing of cross girders 5 m c/c; width of carriage way 7.5m; thickness of wearing coat = 80 mm; kerbs on either side = 600 mm wide × 300 mm deep; width of main girder = 300 mm; width of cross girder = 300 mm; spacing of main girders = 2.5 m c/c. Sketch reinforcement details.
13. Design an interior longitudinal girder of a post tensioned prestressed concrete T beam bridge with the following data: Effective span = 24 m; Width of carriageway = 7.5 m; Kerbs 600 mm wide on either side; Spacing of main girders = 2 m; Spacing of cross girders = 4 m; Loading is IRC Class 70R tracked vehicle; Adopt M50 concrete and high tensile steel strands of 7 ply – 15.2 mm diameter with ultimate strength of 1800 MPa. Use Fe 415 grade steel for supplementary reinforcements. Assume loss ratio = 0.85.
14. Design a welded deck type plate girder bridge for a BG track to suit the following data: Effective span = 40 m; Dead load of track = 10 kN/m; Equivalent uniformly distributed load for bending moment calculations/track = 3498 kN; Equivalent uniformly distributed load for shear force calculations/track = 3815 kN. Take CDA = 0.324. Use plates of Fe410 grade.
15. Design an elastomeric bearing as per IRC 83 Part 2:2018 with the following data.

Maximum vertical design force = 1009 kN

Minimum vertical design force = 666 kN
 Horizontal force along span direction = 10.39 kN
 Horizontal force along width direction = 41.56 kN
 Resultant of all horizontal forces = 42.84 kN
 Relative displacement in the direction of dimension 'a' = 3.77 mm
 Relative displacement in the direction of dimension 'b' = 1.88 mm
 Angle of rotation across the width 'a' of bearing = 0.00381
 Angle of rotation across the length 'b' of bearing = 0.001
 Adopt an elastomeric bearing (based on International Standards) of dimension 250 mm(a) × 400 mm(b)
 Yield strength of steel laminate = 500 MPa

16. Design the main girder of a steel-concrete composite bridge as per relevant IRC standards to cover a span of 36m and for a three-lane carriage way. Use IRC- Class A loading.
17. Find out the distribution coefficient for the outer and central girder having the same moment of inertia as shown in the figure below, when single lane of class AA tracked loading is placed on the deck with maximum eccentricity. The distance between centre lines of bearing of the deck is 16 meters.

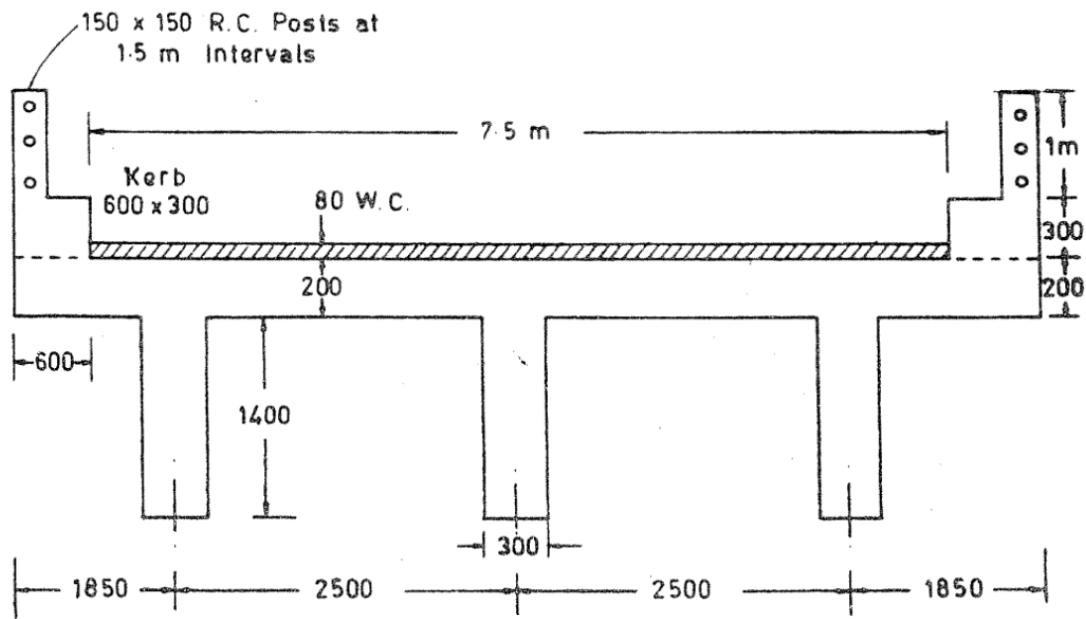

All dimensions are in mm.

Syllabus

Module 1

Introduction to bridges: Importance of site investigation–Classification and components of bridges–Review of road (IRC) and railway (IRS) bridge specifications.

Module 2

Slab and T Beam Bridges: Loads on slabs, Effective width method–Design of straight and skew slab bridges as per relevant IRC loads–Design of interior panel of deck slab, Pigeauds curves–Distribution of loads on Girders – Courbon’s method–Design of T beam bridges (up to three girders only) as per relevant IRC loads.

Module 3

Box culvert and Prestressed Concrete Bridges: Box culvert bridges–General aspects–Design of box culvert bridges (single cell) as per relevant IRC loads–Prestressed Concrete Bridges: Design of single span bridges–Introduction to various forms–Slab bridges–girder bridges–box girder bridges.

Module 4

Steel and Composite bridges: Design of plate girder (bolted and welded connection)–Design of Composite bridge (RCC slab over steel girder)–Theory–Load carrying action of folded plates.

Module 5

Bearings, substructures, and foundations in bridges: Design of elastomeric bearings–Abutments – General features, Loads on abutments, Stability analysis of abutments–Piers – Types, Loads on Piers, Stability analysis of Piers–Bridge Foundations – Types, selection criteria and suitability.

Course Plan

No	Topic	No. of Lectures
1	Introduction to bridges (6)	
1.1	Importance of site investigation	1
1.2	Classification and components of bridges	2
1.3	Review of road (IRC) and railway (IRS) bridge specifications	3
2	Slab and T Beam Bridges (10)	
2.1	Loads on slabs, Effective width method	1
2.2	Design of straight and skew slab bridges as per relevant IRC loads	3
2.3	Design of interior panel of deck slab, Pigeauds curves	1
2.4	Distribution of loads on Girders – Courbon’s method	1

2.5	Design of T beam bridges (up to three girders only) as per relevant IRC loads	4
3	Box culvert and Prestressed Concrete Bridges (9)	
3.1	Box culvert bridges - General aspects	1
3.2	Design of box culvert bridges (single cell) as per relevant IRC loads	3
3.3	Pre-stressed Concrete Bridges: Design of single span bridges-	3
3.4	Introduction to various forms-Slab bridges-girder bridges-box girder bridges	2
4	Steel and Composite bridges (6)	
4.1	Design of plate girder [bolted and welded connection]	3
4.2	Design of Composite bridge (RCC slab over steel girder)	3
5	Bearings, substructures, and foundations in bridges (9)	
5.1	Design of elastomeric bearings	3
5.2	Abutments – General features, Loads on abutments, Stability analysis of abutments	3
5.3	Piers – Types, Loads on Piers, Stability analysis of Piers	2
5.4	Bridge Foundations – Types, selection criteria and suitability	1

Reference Books

1. Johnson Victor. D, “Essentials of Bridge Engineering”, Oxford.
2. N Krishna Raju, “Design of Bridges, Oxford and IBH publishing.
3. Jagadeesh T. R. and Jayaram M. A., “Design of bridge structures”, Prentice Hall of India.
4. Praveen Nagarajan, “Design of Concrete Bridges”, Wiley India Pvt. Ltd.
5. S. Ponnuswamy, “Bridge Engineering”, McGraw Hill Education.
6. Wai-Fah Chen, “Bridge Engineering Handbook: Substructure Design”, CRC Press.
7. V. K. Raina, Raina's Guiding Principles for Design, Construction, Load Capacity Evaluation, Load Testing, & Approximate Costing of 99% of All Bridges, Shroff Publisher.

CODE	COURSE NAME	CATEGORY	L	T	P	CREDIT
222ECE038	STABILITY OF STRUCTURES	PROGRAMME ELECTIVE 3	3	0	0	3

Preamble: The course aims to provide an in-depth understanding on how and under what loading condition, a structure becomes unstable. The student is expected to learn stability analysis of various structures and how this theoretical knowledge can be transferred to design methods and guidelines. The students will be able to appreciate all structural design standards and confidently design various structures.

Course Outcomes: After the completion of the course on Stability of Structures, the student will be able to

CO 1	To Identify the relevance of Stability analysis in structures
CO 2	Perform Stability Analysis of Columns
CO 3	Perform Stability Analysis of Beam - Columns
CO 4	Carryout Stability analysis of Frames with various Boundary and loading conditions
CO 5	To analyse the lateral stability of beams & Buckling of Thin-Walled Open Sections
CO 6	Perform Stability analysis of Plated and shell structures

Mapping of course outcomes with program outcomes

	PO 1	PO 2	PO 3	PO 4	PO 5	PO 6	PO 7
CO 1	1	1	2	2	2	1	1
CO 2	1	1	2	2	2	1	1
CO 3	1	1	2	2	2	1	1
CO 4	1	1	2	2	2	1	1
CO 5	1	1	2	3	3	1	1
CO 6	1	1	2	3	3	1	1

Assessment Pattern

Bloom's Category	End Semester Examination
Remember	10
Understand	15
Apply	25
Analyse	10
Evaluate	–
Create	–

Mark distribution

Total Marks	CIE	ESE	ESE Duration
100	40	60	2.5 hours

Continuous Internal Evaluation Pattern:

Preparing a review article based on peer reviewed original publications (minimum 10 publications shall be referred): 15 marks

Course based task/Seminar/Data collection and interpretation: 15 marks

Test paper 1 no.: 10 marks

Test paper shall include minimum 80% of the syllabus.

End Semester Examination Pattern:

The end semester examination will be conducted by the respective College. There will be two parts; Part A and Part B. Part A will contain 5 numerical/short answer questions with 1 question from each module, having 5 marks for each question (such questions shall be useful in the testing of knowledge, skills, comprehension, application, analysis, synthesis, evaluation and understanding of the students). Students should answer all questions. Part B will contain 7 questions (such questions shall be useful in the testing of overall achievement and maturity of the students in a course, through long answer questions relating to theoretical/practical knowledge, derivations, problem solving and quantitative evaluation), with minimum one question from each module of which student should answer any five. Each question can carry 7 marks.

Note: The marks obtained for the ESE for an elective course shall not exceed 20% over the average ESE mark % for the core courses. ESE marks awarded to a student for each elective course shall be normalized accordingly. For example, if the average end semester mark % for a core course is 40, then the maximum eligible mark % for an elective course is $40+20 = 60$ %.

Model Question Paper**Max Marks 60****Duration 2.5 Hours****PART A****(Answer ALL questions , each question carries 5 marks)**

1. Explain bifurcation buckling and limit load buckling.
2. Explain Rayleigh-Ritz method for estimation of buckling load of columns.
3. Derive the differential equation for a beam-column.
4. Describe in detail torsional and torsional-flexural buckling.
5. Differentiate between thin and thick plates.

PART B**(Answer Any FIVE questions only, each question carries 7 marks)**

6. Obtain the elastic buckling load of the system composed of a rigid bar partially fixed at the base by a rotational spring as shown in the figure. Use energy approach.

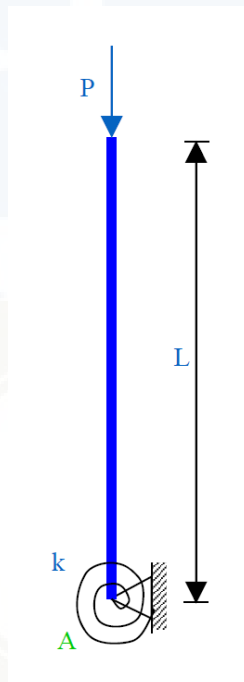

7. Using higher order differential equation representing the buckling behaviour of columns , estimate the buckling load for a column with fixed-fixed conditions
8. Find the buckling load of given beam- column

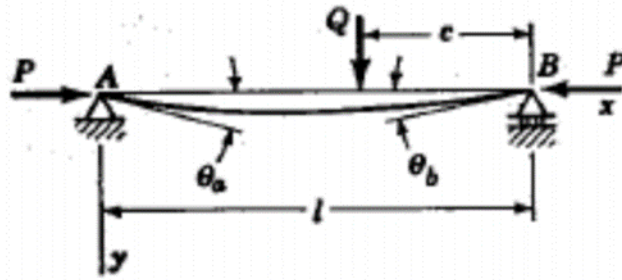

9. Explain post buckling strength.
10. Describe various buckling modes of Thin-walled open sections
11. Find the buckling load of cylindrical shell subjected to uniform external pressure.
12. Find the critical load for a simply supported plate uniformly compressed in one direction.

Syllabus and Course Plan

No	Topic	No. of Lectures
1	Concepts of Stability (6)	
1.1	Introduction - Stability Criteria – Stable, unstable and neutral Equilibrium	2
1.2	Fourth order Elastic- largedeflection of bars - differential equation for generalizedbending problems	2
1.3	Elastic instability of columns-Euler's theory-assumptions and limitations-Energy principles	2
2	Compression Members (9)	
2.1	Higher order Differential equations - analysis for various boundary conditions	2
2.2	Behaviour of imperfect column -initially bent column - eccentrically loaded column	2
2.3	Energy method- Rayleigh Ritz, Galerkin methods	1
2.4	Effect of shear on buckling – Large deflection ofcolumns.	2
2.5	Matrix Stiffness Method – Flexural members and compression members	2
3	Beam Columns & Buckling of Frames (7)	
3.1	Beam Columns:Introduction – Differential Equation forBeam-columns	1
3.2	Solution of differential equation forconcentrated lateral loads - distributed loads – differentend conditions - bottom fixed-bottom hinged	3
3.3	Buckling of frames: Solutions for various end conditions	2
3.4	Horizontal compressionmembers	1
4	Lateral Stability of Beams & Buckling of Thin-Walled Open Sections (7)	
4.1	Lateral Stability of Beams: Differential equations forlateral buckling	2
4.2	Lateral buckling of beams in purebending	1
4.3	Lateral buckling of cantilever and simplysupported I beams	1
4.4	Buckling of Thin-Walled Open Sections: Introduction	1
4.5	Torsional buckling - Torsional flexural buckling	1
4.6	Equilibrium and energy approaches	1
5	Stability of Plates and Shells(11)	
5.1	Stability of Plates -Governing Differential equation - Equilibrium, energy concepts	2
5.2	Buckling of rectangularplates of various end conditions	3
5.3	Finite differencemethod - post-buckling strength	2
6.1	Donnel's Equation – SymmetricalBuckling of Cylinder under uniform axial Compression	2
6.2	Cylinder under uniform external lateral pressure	1
6.3	Cylinder subjected to torsion.	1

Reference Books

1. Chajes, A., " Principles of Structural Stability Theory", Prentice Hall, 1974.
2. Iyengar, N.G.R., "Elastic Stability of Structural Elements", Macmillan India Ltd.,Newdelhi,2007.
3. Ziegler H, "Principles of structural stability", Blarsdell, Wallham, Mass, 1963.
4. Thompson J M, G W Hunt, "General stability of elastic stability", Wiley,New York.
5. Timoshenko, Gere, "Theory of elastic stability", Mc Graw Hill, New York.
6. Don O Brush, B O Almorth, "Buckling of Bars, plates and shells", Mc Graw Hill,1975
7. Cox H L, "The buckling of plates and shells", Macmillam, New York, 1963.
8. AshwiniKukar, "Stability of Structures ", Allied Publishers LTD, New Delhi, 1998.
9. Murali L. Gambir," Stability Analysis and Design of Strucures", Springer-Verlog, Berlin, 2004

CODE	COURSE NAME	CATEGORY	L	T	P	CREDIT
222ECE039	THEORY OF PLATES AND SHELLS	PROGRAMME ELECTIVE 3	3	0	0	3

Preamble: The course aims to provide a basic understating of the behaviour of the plates and shells with different geometry under various types of loads. The student is expected to identify the various thin-walled structures in the form of plates and shellssuitable foruse in different structural systems.

Course Outcomes: After the completion of the course on Theory of Plates and Shellsthe student will be able to

CO 1	Explain the classification of plates, assumptions in the theory of thin plates and bending of long rectangular plates to a cylindrical surface
CO 2	Describe symmetrical bending of circular plates and use the concept to analyse annular plates
CO 3	Derive the differential equations for small deflections of laterally loaded plates for different boundary conditions and solve using Navier and Levy's method
CO 4	Understand the theory of folded plates
CO 5	Explain the theory, load carrying mechanism, state of stress and classification of shells
CO 6	Compute the stresses in cylindrical shell under dead and snow loads

Mapping of course outcomes with program outcomes

	PO 1	PO 2	PO 3	PO 4	PO 5	PO 6	PO 7
CO 1			1				
CO 2	2		1				
CO 3	2		1				
CO 4			1				
CO 5	1		1				
CO 6	1		1				

(1-Weak, 2-Medium, 3- strong)

Assessment Pattern

Bloom's Category	End Semester Examination
Remember	10
Understand	38
Apply	12
Analyse	
Evaluate	
Create	

Mark distribution

Total Marks	CIE	ESE	ESE Duration
100	40	60	2.5 hours

Continuous Internal Evaluation Pattern:

Preparing a review article based on peer reviewed

original publications (minimum 10 publications shall be referred): 15 marks

Course based task/Seminar/Data collection and interpretation: 15 marks

Test paper, 1 no.: 10 marks

Test paper shall include minimum 80% of the syllabus.

End Semester Examination Pattern:

The end semester examination will be conducted by the respective College. There will be two parts; Part A and Part B. Part A will contain 5 numerical/short answer questions with 1 question from each module, having 5 marks for each question (such questions shall be useful in the testing of knowledge, skills, comprehension, application, analysis, synthesis, evaluation and understanding of the students).

Students should answer all questions. Part B will contain 7 questions (such questions shall be useful in the testing of overall achievement and maturity of the students in a course, through long answer questions relating to theoretical/practical knowledge, derivations, problem solving and quantitative evaluation), with minimum one question from each module of which students should answer any five. Each question can carry 7 marks.

Note: The marks obtained for the ESE for an elective course shall not exceed 20% over the average ESE mark % for the core courses. ESE marks awarded to a student for each elective course shall be normalized accordingly. For example, if the average end semester mark % for a core course is 40, then the maximum eligible mark % for an elective course is $40+20 = 60\%$.

Model Question Paper**QP CODE:****Reg No.:** _____**Name:** _____**APJ ABDUL KALAM TECHNOLOGICAL UNIVERSITY SECOND SEMESTER
M.TECH. DEGREE EXAMINATION,****MONTH & YEAR****Course Code: XXXX****THEORY OF PLATES AND SHELLS**

Max. Marks: 60

Duration: 2.5 hours

PART A***(Answer ALL questions; each question carries 5 marks)***

1. Show that for the small deflection of a plate subjected to pure bending, the directions of zero slope and max slope are perpendicular to each other.
2. A solid circular plate of radius 0.3 m with its outer edge completely restrained is subjected to a pressure load of 10 MPa. If the allowable stress in the plate is limited to 100 MPa, determine (i) The thickness of the plate, (ii) The maximum deflection, (iii) The stress at the centre of the plate. Take $E = 200 \text{ GPa}$, $\nu = 0.3$.
3. How would you compare Navier solution and Levy's solution as used for simply supported rectangular plates?
4. How shells are classified based on Gaussian curvature?
5. Show that there is a compression along the meridians of a spherical shell of radius a subjected to the action of its own weight of magnitude q per unit area.

PART B***(Answer any FIVE questions; each question carries 7 marks)***

6. Derive the differential equation for the cylindrical bending of long rectangular plates.
7. Derive the differential equation for symmetrical bending of laterally loaded circular plates and obtain the expression for maximum deflection for circular plate with clamped edges.
8. Find the deflection of a circular plate (radius a) with a hole (radius b) at the centre and subjected to moments M_1 and M_2 at the inner and outer edges respectively.

9. Obtain the differential equation for the small deflections of a laterally loaded plate.
10. A rectangular plate ($a \times b \times h$), simply supported on all four edges is subjected to sinusoidal load ($q_0 \sin \frac{\pi x}{a} \sin \frac{\pi y}{b}$) distributed over the surface of the plate. Find expressions for deflection (w), bending moments (M_x, M_y)
11. Explain the load carrying mechanism of shells.
12. Develop the expressions for the displacements in symmetrically loaded shells having the form of a surface of revolution.

Syllabus

Module 1

Introduction- Classification of plates -Assumptions in the theory of thin plates- Bending of long rectangular plates to a cylindrical surface. Pure bending of plates- Slope and curvature - Relations between bending moments and curvature- Particular cases of pure bending.

Module 2

Symmetrical bending of circular plates-Differentialequation. Uniformly loaded circular plates with simplysupported and fixed boundary conditions-Annular plate with uniform moments and shear forces along the boundaries.

Module 3

Small deflections of laterally loaded plates-Differentialequation-Boundary conditions-Navier solution and Levy'ssolution for simply supported rectangular plates.

Module 4

Theory-Load carrying action of folded plates.

Classical shell theory- Load carrying mechanism of shells - Types of state of stress for thin shells-Classification of Shells.

Module 5

Shells in the form of a surface of revolution, displacements. Membrane theory of cylindrical shells. General theory of cylindrical shells-A circular cylindrical shell loaded symmetrically with respect to its axis- stresses in cylindrical shell under dead and snow loads.

Course Plan

No	Topic	No. of Lectures
1	Pure Bending of Plates (10)	
1.1	Introduction- Classification of plates -Assumptions in the theory of thin plates. Bending of long rectangular plates to a cylindrical surface – Differential equation.	2
1.2	Pure bending of plates-Slope and curvature.	2
1.3	Relations between bending moments and curvature-Particular cases of pure bending.	6
2	Circular Plates (6)	
2.1	Symmetrical bending of circular plates-Differentialequation.	1
2.2	Uniformly loaded circular plates with simplysupported and fixed boundary conditions	2
2.3	Annular plate withuniform moments and shear forces along the boundaries.	3
3	Laterally loaded Plates (10)	
3.1	Small deflections of laterally loaded plates-Differential equation - Boundary conditions.	4
3.2	Simply supported rectangular plates under sinusoidal load.	2
3.3	Navier solution and Levy's solution for simply supported rectangular plates.	4
4	Folded Plates and shells (6)	
4.1	Theory-Load carrying action of folded plates.	2
4.2	Classical shell theory- Load carrying mechanism of shells.	2
4.3	Types of state of stress for thin shells-Classification of shells.	2
5	Theory of Shells (8)	
5.1	Displacements in symmetrically loaded shells having the form of a surface of revolution.	2
5.2	Membrane theory of cylindrical shells.	2
5.3	General theory of cylindrical shells-A circular cylindrical shell loaded symmetrically with respect to its axis- stresses in cylindrical shell under dead and snow loads.	4

Reference Books

1. Timoshenko S.P. and Krieger S. W., Theory of Plates and Shells, Tata McGraw Hill, 1959
2. Chandrashekhara K., Theory of Shells, Universities(India)Press Ltd., 2001
3. Ramaswamy G. S., Design and Construction of Concrete Shell Roofs, CBS Publishers, 2005
4. Bairagi N. K., Plate Analysis, Khanna Publishers, 1986

5. Kelkar V. S. and Sewell R.T., Fundamentals of the Analysis and Design of Shell Structures, Prentice Hall Inc., 1987
6. T.K.Varadan& K. Bhaskar, Analysis of plates – Theory and problems, Narosha Publishing Co., 1999.
7. Reddy J N., Theory and Analysis of Plates and Shells, Taylor and Francis, 2006

APJ ABDUL KALAM
TECHNOLOGICAL
UNIVERSITY



APJ ABDUL KALAM
TECHNOLOGICAL
UNIVERSITY

SEMESTER II

PROGRAM ELECTIVE IV

Estd.



2014

ADVANCED COMPOSITE STRUCTURES

CODE	COURSE NAME	CATEGORY	L	T	P	CREDIT
222ECE042	Advanced Composite Structures	Programme Elective	3	0	0	3

Preamble:

Composite materials are finding immense application in the field of aerospace, automobile and civil engineering presently due to its outstanding material capability. This course will equip the students with the specialist knowledge and skills required by the leading employers in aerospace, marine, construction and renewable energy industries to design and develop next generation environmental-friendly and structural-efficient advanced lightweight and composite materials and components.

Course Outcomes: After the completion of the Advanced Composite Structures course the student will be able to

CO 1	An ability to identify the properties of fibre and matrix materials used in commercial composites, as well as some common manufacturing techniques.
CO 2	A basic understanding of linear elasticity with emphasis on the difference between layered composite materials and isotropic materials.
CO 3	Apply constitutive equations of composite materials and understand the mechanical behaviour at micro and macro levels.
CO 4	An ability to predict the failure mode and strength of laminated composite structures.
CO 5	An ability to use the ideas developed in the analysis of composites towards using composites in various fields of engineering.

Mapping of course outcomes with program outcomes

	PO 1	PO 2	PO 3	PO 4	PO 5	PO 6	PO 7
CO 1			3	3	2		
CO 2			3	3	2		
CO 3			3	3	2		
CO 4			3	3	2		
CO 5			3	3	2		

Assessment Pattern

Bloom's Category	End Semester Examination
Remember	15
Understand	15
Apply	25
Analyse	5
Evaluate	-
Create	-

Mark distribution

Total Marks	CIE	ESE	ESE Duration
100	40	60	2.5 hours

Continuous Internal Evaluation Pattern:

Preparing a review article based on peer reviewed original publications (minimum 10 publications shall be referred): 15 marks

Course based task/Seminar/Data collection and interpretation: 15 marks

Test paper, 1 no.: 10 marks

Test paper shall include minimum 70% of the syllabus.

End Semester Examination Pattern:

The end semester examination will be conducted by the respective College. There will be two parts; Part A and Part B. Part A will contain 5 numerical/short answer questions with 1 question from each module, having 5 marks for each question (such questions shall be useful in the testing of knowledge, skills, comprehension, application, analysis, synthesis, evaluation and understanding of the students). Students should answer all questions. Part B will contain 7 questions (such questions shall be useful in the testing of overall achievement and maturity of the students in a course, through long answer questions relating to theoretical/practical knowledge, derivations, problem solving and quantitative evaluation), with minimum one question from each module of which student should answer any five. Each question can carry 7 marks.

Note: The marks obtained for the ESE for an elective course shall not exceed 20% over the average ESE mark % for the core courses. ESE marks awarded to a student for each elective course shall be normalized accordingly. For example, if the average end semester mark % for a core course is 40, then the maximum eligible mark % for an elective course is $40 + 20 = 60\%$.

Model Question paper

PART A

Answer **all** questions.

All Questions carry **equal** marks

1. What is a composite? Give some examples for naturally found composites
2. Explain how to calculate the effective moduli of a composite lamina in terms of its constituent properties
3. What is Classical Lamination Theory? Explain its significance in composite analysis.
4. Explain how to determine the laminae stresses and strains from the analysis of a laminate?
5. Explain the different boundary conditions considered in plate analysis with examples.

PART B

Answer any **FIVE** questions only

6. (a) What are prepregs? Explain briefly the pultrusion method in composite Construction
(b) Briefly explain the classification of composites based on the geometry of reinforcement.
7. (a) Derive the stress and strain transformation relations for a unidirectional lamina of arbitrary orientation
(b) Explain how to calculate the effective moduli of a composite lamina in terms of its constituent properties
8. (a) Name the failure theories adopted in composite analysis. Explain any two of them in detail.
(b) What are the effects of laminate stacking sequence on the stress-strain relations of a laminate?
9. Calculate the A, B, D matrices for a four ply laminate $[\pm 45^{\circ}]_s$, each layer of which is of 3mm thickness. The stiffness matrices of each layer are given by

$$[\bar{Q}]_1 = [\bar{Q}]_4 = \begin{bmatrix} 6.55 & 5.15 & 4.50 \\ 5.15 & 6.55 & 4.50 \\ 4.50 & 4.50 & 5.15 \end{bmatrix}$$

$$[\bar{Q}]_2 = [\bar{Q}]_3 = \begin{bmatrix} 6.55 & 5.15 & -4.50 \\ 5.15 & 6.55 & -4.50 \\ -4.50 & -4.50 & 5.15 \end{bmatrix}$$

10. Derive the equilibrium equations for a laminate plate bending.
11. For the laminate shown below, find the stresses in each of the layer if it is subjected to $N_{xx} = 2\text{MN/m}$ and $N_{yy} = 2\text{MN/m}$. Assume the lamina properties as $E_l = 50\text{GPa}$, $E_t = 15\text{GPa}$, $G_{lt} = 6\text{GPa}$

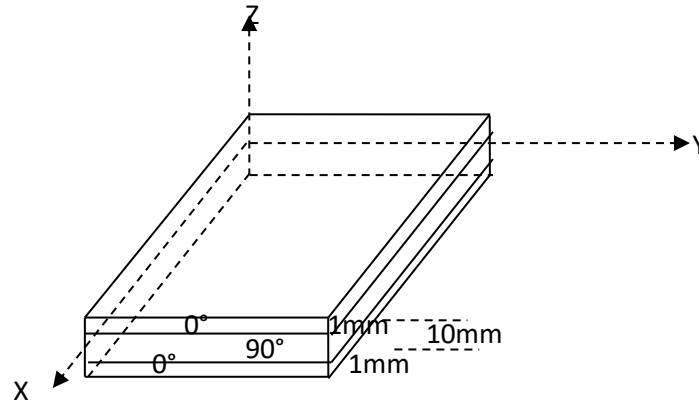

12. Find the maximum value of $S > 0$ if a stress of $\sigma_x = 2S$, $\sigma_y = -3S$, and $\tau_{xy} = 4S$ is applied to a 60° Graphite/epoxy Lamina. Use Tsai-Hill Failure theory.
Given $(\sigma_1^t)_{ult} = 1500\text{MPa}$, $(\sigma_1^c)_{ult} = 1500\text{MPa}$, $(\sigma_2^t)_{ult} = 40\text{MPa}$, $(\sigma_2^c)_{ult} = 246\text{MPa}$,
 $(\tau_{21})_{ult} = 68\text{MPa}$

Syllabus and Course Plan (For 3 credit courses, the content can be for 40 hrs and for 2 credit courses, the content can be for 26 hrs. The audit course in third semester can have content for 30 hours).

No	Topic	No. of Lectures
1	Introduction to Composite Fundamentals (6)	
1.1	Definition of composites, Objectives, constituents and Classification of composites.	2
1.2	Basic terminology used in fibre reinforced composite materials- Laminae, Laminates General Characteristics of reinforcement and classifications, Characteristics of matrix- Polymer matrix, Thermoplastics and thermosetting resins, Glass transition temperature , Prepregs	2
1.3	Structural applications of Composite Materials	1
1.4	Manufacturing of Composites	1
2	Macro and micro mechanical behaviour of composite lamina (9)	
2.1	Review of Basic Equations of Mechanics and Materials, Number of elastic constants and reduction from 81 to 2 for different materials. Transversely isotropic materials.	2
2.2	Stress-Strain relations for a unidirectional and orthotropic lamina	2
2.3	Stress-strain relations for a lamina of arbitrary orientation	1
2.4	Volume and Mass Fractions, Density and Void content	1

2.5	Effective Moduli of a continuous fibre-reinforced lamina - Models based on mechanics of materials, theory of elasticity and experimental methods, Mechanics of materials approach to strength, Numerical Examples	2
2.6	Failure of Continuous Fibre-reinforced orthotropic Lamina. Maximum stress/strain criteria, Tsai-Hill and Tsai-Wu criterion.	1
3	Macromechanical Behaviour of a Laminate (8)	
3.1	Classical Lamination Theory-Lamina Stress-strain behaviour, In-plane forces, stress-strain variation in a laminate, resultant laminate stresses and strains	2
3.2	Special cases of laminate stiffnesses-symmetric and antisymmetric laminates, cross ply and angle ply laminates, quasi-isotropic laminates	3
3.3	Effects of stacking sequence-Laminate code	1
3.4	Determination of laminae stresses and strains, numerical examples	2
4	Strength of Laminates (9)	
4.1	Laminate strength analysis procedure, Failure envelopes,	3
4.2	Analysis of laminates after initial failures, Progressive failure Analysis. Numerical Examples	2
4.3	Free-Edge Interlaminar Effects , Analysis of free edge interlaminar stresses	2
4.4	Hygrothermal effects on material properties and response of composites, Numerical Examples.	2
5	Analysis of laminated Plates (8)	
5.1	Governing equations and boundary conditions, Solution techniques	3
5.2	Application of Plate Theory-Bending-General Laminates, Deflection of laminated plates	2
5.3	Buckling- Governing equations, Specially orthotropic and symmetric angle ply laminates	3

Reference Books

1. Jones M. Roberts, Mechanics of Composite Materials, Taylor and Francis, 1998
2. Reddy, J.N , Mechanics of Laminated Composite Plates: Theory and Analysis, CRC Press, 2003
3. Calcote, L. R., Analysis of Laminated Composite structures, Van Nostrand, 1969
4. Vinson, J. R. and Chou P, C., Composite materials and their use in Structures, Applied Science Publishers, Ltd. London, 1975
5. Agarwal, B.D. and Broutman, L. J., Analysis and performance of Fibre composites. 3rdEdn.

CODE	COURSE NAME	CATEGORY	L	T	P	CREDIT
222ECE043	DESIGN OF EARTHQUAKE RESISTANT STRUCTURES	PROGRAMME ELECTIVE 4	3	0	0	3

Preamble: The course provides the basic principles of earthquake resistant design of structures. Students are introduced to the engineering aspects of earthquakes, their characterisation and effects. The course covers seismic design force computation, design and detailing as per Indian Standards. An introduction to seismic evaluation and retrofitting is also included.

Course Outcomes: After the completion of the course on Design of Earthquake Resistant Structures the student will be able to

CO 1	Describe various engineering aspects of earthquakes, earthquake effects and earthquake resistant design.
CO 2	Apply IS code provisions for the analysis, design and detailing of earthquake resistant structures.
CO 3	Develop earthquake response spectrum.
CO 4	Perform response spectrum analysis of multi-storied frames.
CO 5	Analyse and design shear walls.
CO 6	Describe different strategies for seismic evaluation and seismic retrofitting.

Mapping of course outcomes with program outcomes

	PO 1	PO 2	PO 3	PO 4	PO 5	PO 6	PO 7
CO 1			1				
CO 2	1		2				
CO 3	2		2				
CO 4	1		2				
CO 5	1		2				
CO 6			1				

(1- Weak, 2-Medium, 3- strong)

Assessment Pattern

Bloom's Category	End Semester Examination
Remember	
Understand	25
Apply	14
Analyse	21
Evaluate	
Create	

Mark distribution

Total Marks	CIE	ESE	ESE Duration
100	40	60	2.5 hours

Continuous Internal Evaluation Pattern:

Preparing a review article based on peer reviewed original publications (minimum 10 publications shall be referred): 15 marks

Course based task/Seminar/Data collection and interpretation: 15 marks

Test paper, 1 no.: 10 marks

Test paper shall include minimum 80% of the syllabus.

End Semester Examination Pattern:

The end semester examination will be conducted by the respective College. There will be two parts; Part A and Part B. Part A will contain 5 numerical/short answer questions with 1 question from each module, having 5 marks for each question (such questions shall be useful in the testing of knowledge, skills, comprehension, application, analysis, synthesis, evaluation and understanding of the students).

Students should answer all questions. Part B will contain 7 questions (such questions shall be useful in the testing of overall achievement and maturity of the students in a course, through long answer questions relating to theoretical/practical knowledge, derivations, problem solving and quantitative evaluation), with minimum one question from each module of which students should answer any five. Each question can carry 7 marks.

Note: The marks obtained for the ESE for an elective course shall not exceed 20% over the average ESE mark % for the core courses. ESE marks awarded to a student for each elective course shall be normalized accordingly. For example, if the average end semester mark % for a core course is 40, then the maximum eligible mark % for an elective course is $40 + 20 = 60\%$.

Model Question Paper**QP CODE:****Reg No.:** _____**Name:** _____**APJ ABDUL KALAM TECHNOLOGICAL UNIVERSITY SECOND SEMESTER
M.TECH. DEGREE EXAMINATION,****MONTH & YEAR****Course Code: XXXX****DESIGN OF EARTHQUAKE RESISTANT STRUCTURES**

Max. Marks: 60

Duration: 2.5 hours

PART A(Answer **ALL** questions; each question carries 5 marks)

1. Distinguish between *magnitude* and *intensity* of earthquake.
2. Explain the philosophy of earthquake resistant design.
3. Can the exact value of maximum seismic response of a multi-degree of freedom be determined using response spectrum analysis? Explain.
4. Explain the significance of ductility in earthquake resistant design.
5. What do you mean by retrofitting of structures? Explain the retrofitting methods used for RC columns.

PART B(Answer **any FIVE** questions; each question carries 7 marks)

6. Figure shows the plan of a four storied RC framed structure to be constructed in Bangalore. Height of each story is 3.0 m. Calculate the seismic forces at various floor levels.

Data given:

- Column section : 23×60 cm.
 Beam section : 23×55 cm.
 Slab Thickness : 13 cm.
 Thickness of brick wall around: 23 cm.
 Live load on floors : 4 kN/m^2
 Live load on roof : 1.5 kN/m^2
 Unit weight of concrete : 25 kN/m^3
 Unit weight of brick wall : 20 kN/m^3

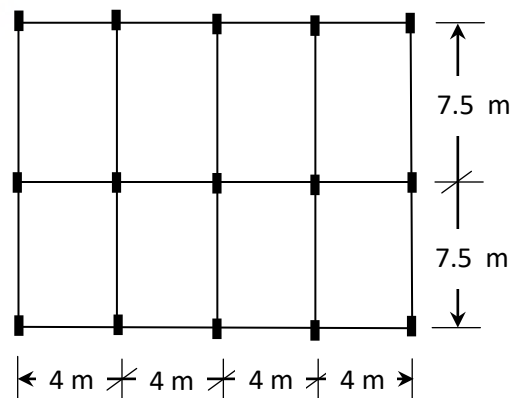

Frame type : SMRF

Type of soil : Soft soil

Missing data may be suitably assumed.

7. Explain the factors which ensure proper seismic behaviour of a building.
8. The natural frequencies (in rad/s) of the three storied shear building shown below are 6.57, 16.91 and 24.67. The mass normalized modal matrix is

$$\begin{bmatrix} 0.0034 & 0.0066 & 0.0067 \\ 0.0061 & 0.0038 & -0.0069 \\ 0.0080 & -0.0072 & 0.0031 \end{bmatrix}$$

The damping may be assumed as 5% for all modes. Using response spectrum method calculate the base shear.

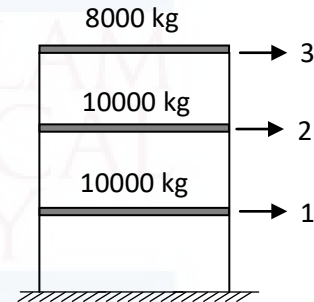

Assume that the building is to be constructed in Zone V and the foundation soil is Type I (hard soil). The frame may be assumed as SMRF. Take importance factor as 1.5. Use SRSS rule to combine the modal responses.

9. Explain how the ductility of RC members can be increased.
10. Plan of a single storey building having two shear walls in each direction is shown. The shear walls are 6 m long and 200 mm thick. Design shear force on the building is 120 kN in either direction. Determine the design lateral force in shear wall A using the torsion provisions of the IS code.

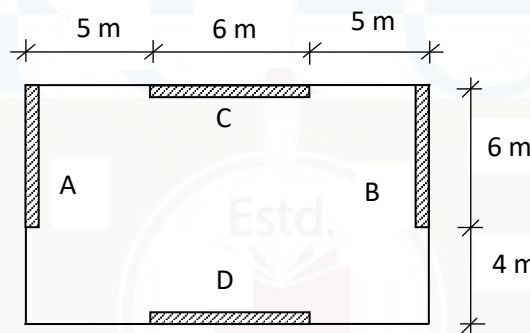

11. A slender shear wall of length 6 m and thickness 200 mm carries an axial load of 2700 kN. The wall is reinforced with 10# bars at 250 mm c/c in two layers. If M25 concrete and Fe415 steel are used, estimate the moment of resistance of the wall.
12. What is seismic evaluation? When is it required? Explain the different steps in seismic evaluation.

Syllabus

Module 1

Introduction to earthquakes and earthquake engineering, Mechanism of earthquake, seismic waves, effects of earthquakes. Measurement of earthquakes, magnitude and intensity, seismographs. Strong motion characteristics, response spectrum, Fourier spectrum. Characteristics of response spectrum, Design spectrum, construction of tripartite response spectrum.

Module 2

Effect of architectural features and structural irregularities. Damages of structures during past earthquakes, principles of earthquake resistant construction.

Philosophy of earthquake resistant design. Code provisions as per IS:1893 and IS:4326.

Module 3

Design seismic force calculation in multi storied frames. Dynamic analysis, Introduction to response spectrum analysis – theoretical aspects, Modal combination rules.

Design seismic force calculation in multi storied frames using response spectrum method.

Module 4

Ductility – Significance, Ductility factors. Ductile detailing considerations as per IS:13920. Design and detailing of structural members. Reinforcement detailing in joints.

Module 5

Torsion – code provisions, Shear walls – design force calculation, Design of shear wall, Design and detailing for earthquake resistance – Discussion of code provisions in IS 13920.

Repair and rehabilitation. Seismic evaluation and vulnerability assessment – Methods, Disaster mitigation, Response reduction techniques, Base isolation.

Course Plan

No	Topic	No. of Lectures
1	Earthquakes and Response Spectrum (9)	
1.1	Earthquakes, Mechanism, Elastic rebound theory. Seismic waves, Effects of earthquakes	3
1.2	Size of earthquake – magnitude & intensity, moment magnitude Measurement of earthquakes – seismographs	2
1.3	Strong motion characteristics, response spectrum, Fourier spectrum	2

1.4	Characteristics of response spectrum, design spectrum, construction of tripartite response spectrum	2
2	Earthquake Effects and Philosophy of Earthquake Resistant Construction (7)	
2.1	Structural irregularities, Effect of architectural features, Damages during past earthquakes.	2
2.2	Seismo-resistant building architecture	1
2.3	Philosophy of earthquake resistant construction. Principle of earthquake resistant construction	2
2.4	Introduction of IS codes (1893 & 4326), Code provision	2
3	Design Seismic Force Computation (8)	
3.1	Seismic force computation using IS code provisions	2
3.2	Response spectrum analysis – theoretical aspects, Modal combination rules	2
3.3	Seismic force computation using Response spectrum method	2
3.4	Modal combination using ABS, SRSS & CQC rules	2
4	Ductility Aspects and Ductile Detailing (7)	
4.1	Ductility – significance in earthquake resistant design, Ductility factors.	2
4.2	Ductile detailing considerations as per IS:13920	2
4.3	Design & detailing of structural members & joints	3
5	Torsion and Shear Walls (9)	
5.1	Torsion – code provisions Design eccentricity computation	1
5.2	Shear walls – design force calculation. Design of shear wall.	3
5.3	Seismic evaluation – methods	2
5.4	Repair and rehabilitation – methods	2
5.5	Response reduction techniques, Base isolation	1

Reference Books

1. Pankaj Agarwal and Manish Shrikhande, Earthquake Resistant Design of Structures, Prentice- Hall of India, New Delhi.
2. Anil K Chopra, Dynamics of Structures, Prentice- Hall of India, New Delhi.
3. S. K. Duggal-Earthquake Resistant Design of Structures-Oxford University Press-2007
4. T.K. Datta, Seismic Analysis of Structures, John Wiley & Sons (Asia) Pte Ltd.
5. IS: 1893-2016, Indian Standard criteria for Earthquake Resistant Design of Structures, Bureau of Indian Standards, New Delhi
6. IS: 4326-2013, Indian Standard code for practice for Earthquake Resistant Design and Construction of Buildings, Bureau of Indian Standards, New Delhi.
7. IS: 13920-2006, Indian Standard Ductile Detailing of RCC Structures subjected to seismic forces Code of practice, Bureau of Indian Standards, New Delhi

CODE	COURSE NAME	CATEGORY	L	T	P	CREDIT
222ECE044	THEORY OF PLASTICITY	PROGRAMME ELECTIVE 4	3	0	0	3

Preamble: Nil

Course Outcomes: After the completion of the course the student will be able to

CO 1	Understand stress, strain, deformations, the relation between stress and strain, and plastic deformation in solids.
CO 2	Understand plastic stress-strain relations and associated flow rules.
CO 3	Perform stress analysis in beams and bars including Material nonlinearity.
CO 4	Analyze the yielding of a material according to different yield theories for a given state of stress.
CO 5	Interpret the importance of the plastic deformation of metals in engineering problems.

Mapping of course outcomes with program outcomes

	PO 1	PO 2	PO 3	PO 4	PO 5	PO 6	PO 7
CO 1	-	-	-	-	-	-	-
CO 2	-	-	-	3	-	-	-
CO 3	-	-	-	3	-	-	-
CO 4	-	-	-	3	2	-	-
CO 5	3	2	-	3	-	-	-

Assessment Pattern

Bloom's Category	End Semester Examination
Apply	10
Analyse	20
Evaluate	10
Create	-

Mark distribution

Total Marks	CIE	ESE	ESE Duration
100	40	60	2.5 hours

Continuous Internal Evaluation Pattern:

Continuous Internal Evaluation: 40 marks Micro project/Course based project : 20 marks

Course based task/Seminar/Quiz : 10 marks

Test paper, 1 no. : 10 marks

The project shall be done individually. Group projects not permitted. Test paper shall include minimum 80% of the syllabus.

End Semester Examination Pattern:

The end semester examination will be conducted by the University. There will be two parts; Part A and Part B. Part A contain 5 numerical questions (such questions shall be useful in the testing of knowledge, skills, comprehension, application, analysis, synthesis, evaluation and understanding of the students), with 1 question from each module, having 5 marks for each question. Students shall answer all questions. Part B contains 7 questions (such questions shall be useful in the testing of overall achievement and maturity of the students in a course, through long answer questions relating to theoretical/practical knowledge, derivations, problem solving and quantitative evaluation), with minimum one question from each module of which student shall answer any five. Each question can carry 7 marks. Total duration of the examination will be 150 minutes.

Course Level Assessment Questions**Course Outcome 1 (CO1): Understand stress, strain, deformations, the relation between stress and strain, and plastic deformation in solids.**

1. Explain spherical and deviatoric stress tensors.
2. Explain various factors affecting plastic deformation.
3. Derive the equilibrium equation in two dimensions considering the body forces.
4. Write a note on octahedral stresses.
5. Explain effective and representative strain.
6. Derive an expression for cubical dilatation stress.
7. Explain true stress and true strain.

Course Outcome 2 (CO2): Understand plastic stress-strain relations and associated flow rules.

1. Explain various theories of plastic flow
2. Explain the different stress strain diagram employed to describe elasto-plastic behaviour of materials.

3. Derive an expression for cubical dilation strain.
4. Enumerate different types of materials encountered in practice from plastic flow point of view. Also sketch the corresponding mechanical models.
5. Explain St. Venants theory of plastic flow in detail. What are the limitations of this theory?
6. Write a short note on Luder's line.

Course Outcome 3(CO3): Perform stress analysis in beams and bars including Material nonlinearity.

1. A rectangular beam having linear stress strain behaviour is 80 mm wide and 120 mm deep. it is 3 m long simply supported at the ends and carries a uniformly distributed load over the entire span. The load is increased so that the outer 30 mm depth of the beam yields plastically. If the yield stress for the beam is 240MPa, plot the residual stress distribution in the beam
2. A hollow circular shaft of inner radius 30 mm and outer radius 60 mm is subjected to a twisting moment so that the outer 10 mm deep shell yields plastically. the yield stress in shear for the shaft material is 160 mega pascal and it is made of a non-linear material whose shear stress strain curve given by $j = 300g^0$. If the twisting moment is now released determine the residual stress distribution in the shaft. Assume $G = 80 \text{ GPa}$ for the shaft material
3. A circular shaft of inner radius 40 mm and outer radius 100 mm is subjected to a twisting couple so that the outer 20 mm deep shell yields plastically. Determine the twisting couple applied to the shaft. Yield stress in shear for the shaft material is 145 N/mm^2 . also determine the couple for full yielding

Course Outcome 4 (CO4): Analyze the yielding of a material according to different yield theories for a given state of stress.

1. What do you mean by yield criteria? Explain any two yield criteria are commonly used.
2. Derive the equation for theory of plastic torsion of circular bar subjected to torsion for following cases.
 - i) Incipient yielding
 - ii) Elasto plastic yielding
 - iii) Fully yielding.
3. Explain experimental verification of yield criteria using Quinny and Taylor's experiments.

Course Outcome 5 (CO5): Interpret the importance of the plastic deformation of metals in engineering problems.

1. Explain various factors affecting plastic deformation.
2. Write short notes on the following

i) Recovery, recrystallization and grain growth.

ii) Flow figures of luder's line.

Model Question Paper

APJ ABDUL KALAM TECHNOLOGICAL UNIVERSITY

M.TECH DEGREE EXAMINATION

THEORY OF PLASTICITY

Time 2.5 hrs

Maximum: 60marks

PART A (Answer all questions; each question carries 5 marks)

1. The state of stress at a point in a stressed body is given below:

$$\sigma_{ij} = \begin{bmatrix} 50 & 50 & -40 \\ 50 & -30 & 30 \\ -40 & 30 & -100 \end{bmatrix} \text{ MPa}$$

Calculate stress invariants, principal stresses, spherical and deviatoric stress tensor

2. A material is to be loaded to a stress state

$$[\sigma_{ij}] = \begin{bmatrix} 50 & -30 & 0 \\ -30 & 90 & 0 \\ 0 & 0 & 0 \end{bmatrix} \text{ MPa}$$

What should be the minimum uniaxial yield stress of the material so that it does not fail, according to the Trescacrriterion?

3. Explain st.venants theory of plastic flow?

4. A hollow circular shaft of inner radius 30 mm and outer radius 60 mm is subjected to a twisting moment so that the outer 10 mm deep shell yields plastically. the yield stress in shear for the shaft material is 160 mega pascal and it is made of a non-linear material whose shear stress strain curve given by $\tau = 300\gamma^0.5$. If the twisting moment is now released determine the residual stress distribution in the shaft. Assume $G = 80 \text{ GPa}$ for the shaft material.

5. What are assumptions of slip line theory?

PART B (Answer any five questions; each question carries 7 marks)

6. Derive the equation of generalized Hook's Law

7. Derive the equilibrium equation in two dimensions considering the body forces.

8. What do you mean by yield criteria? Explain any two yield criteria are commonly used?

9. A rectangular beam having linear stress strain behaviour is 80 mm wide and 120 mm deep. it is 3 m long simply supported at the ends and carries a uniformly distributed load over the entire span. The load is increased so that the outer 30 mm depth of the beam yields plastically. If the yield stress for the beam is 240MPa, plot the residual stress distribution in the beam
10. Explain experimental verification of yield criteria using Quinny and Taylor's experiments.
11. Derive the equation for theory of plastic torsion of circular bar subjected to torsion for following cases.
- Incipient yielding
 - Elasto plastic yielding
13. A circular shaft of inner radius 40 mm and outer radius 100 mm is subjected to a twisting couple so that the outer 20 mm deep shell yields plastically. Determine the twisting couple applied to the shaft. Yield stress in shear for the shaft material is 145 N/mm². also determine the couple for full yielding

Syllabus and Course Plan

No	Topic	No. of Lectures
1	Brief review of fundamentals of elasticity: Concept of stress, stress invariants.	2hr
1.1	Principal Stresses, octahedral normal and shear stresses, spherical and deviatoric stress,	2hr
1.2	Stress transformation; concept of strain, engineering and natural strains, octahedral strain, deviator and spherical strain tensors,	1hr
1.3	strain rate and strain rate tensor, cubical dilation, generalized Hooke's law, numerical problems	1hr
2	Plastic Deformation of Metals: Crystalline structure in metals, mechanism of plastic deformation, factors affecting plastic deformation	1hr
2.1	Strain hardening, recovery, re crystallization and grain growth, flow figures or Luder's cubes	1hr
2.2	Yield Criteria: Introduction, yield or plasticity conditions, Von Mises and Tresca criterion,	1hr
2.3	Geometrical representation, yield surface, yield locus (two-dimensional stress space), experimental evidence for yield	1hr
3	Stress-Strain Relations: Idealised stress-strain diagrams for different material models	1hr
3.1	Empirical equations, Levy-Von Mises equation, Prandtl - Reuss and Saint Venant theory	2hr
3.2	Experimental verification of Saint Venant's theory of plastic	1hr

	flow.	
3.3	Concept of plastic potential, maximum work hypothesis, mechanical work for deforming a plastic substance.	2hr
4	Bending of Beams: Stages of plastic yielding, analysis of stresses,	3hr
4.1	Linear and nonlinear stress strain curve, problems. Torsion of Bars: Introduction, plastic torsion of a circular bar,	3hr
4.2	Elastic perfectly plastic material, elastic work hardening of the material.	1hr
4.3	Numerical problems.	2hr
5	Slip Line Field Theory: Introduction, basic equations for incompressible two-dimensional flows,	2hr
5.1	Continuity equations, stresses in conditions of plain strain,	2hr
5.2	convention for slip lines, the geometry of slip line field,	1hr
5.3	Properties of the slip lines, construction of slip line nets.	2hr

Reference Books

1. Theory of Plasticity and Metal forming Process Sadhu Singh Khanna Publishers, Delhi.
2. Chakrabarty, J, Theory of Plasticity, McGraw Hill, New York.
3. Advanced Mechanics of solids L. S. Srinath Tata Mc. Graw Hill 2009
4. Johnson and Mellor, "Plasticity for Mechanical Engineers", Ban Nostrand.
5. R.Hill , "The Mathematic theory of Plasticity", Oxford Publication.
6. Basic Engineering Plasticity DWA Rees Elsevier 1st Edition
7. Engineering Plasticity W. Johnson and P. B. Mellor Van NoStrand Co. Ltd 2000
8. Chen, W.F., and Han, D.J., Plasticity for Structural Engineers, Springer Verlag.
9. Kachanov, L.M., Fundamentals of the Theory of Plasticity, Mir Publishers, Moscow.
10. Martin, J.B., Plasticity: Fundamentals and General Results, MIT Press, London.
11. Plasticity: Fundamentals and applications, P. M. Dixit and U. S. Dixit

CODE	COURSE NAME	CATEGORY	L	T	P	CREDIT
222ECE045	ENGINEERING FRACTURE MECHANICS	PROGRAMME ELECTIVE 4	3	0	0	3

Preamble: This course provides the fundamental aspects of Fracture Mechanics. The students will be exposed to the analysis of fracture of linear and non-linear materials and apply these concepts to structural components. The pre-requisite of this course is Continuum Mechanics, Mechanics of Solids(Desirable)

Course Outcomes: After the completion of the course the student will be able to

CO 1	Fundamental understanding of fracture mechanics.
CO 2	Ability to analyze and diagnose fractures of linear elastic materials
CO 3	Analyze and diagnose fractures of non-linear materials
CO 4	Assessment of Critical crack growth
CO 5	Apply fracture and fatigue concepts for design of structural components.

Mapping of course outcomes with program outcomes

	PO 1	PO 2	PO 3	PO 4	PO 5	PO 6	PO 7
CO 1	2		2	2	2	2	
CO 2	3		3	3	3	3	
CO 3	3		3	3	3	3	
CO 4	3		3	3	3	3	
CO 5	3		3	3	3	3	
CO 6							

Assessment Pattern

Bloom's Category	End Semester Examination
Apply	25
Analyse	25
Evaluate	10
Create	

Mark distribution

Total Marks	CIE	ESE	ESE Duration
100	40	60	2.5 hours

Continuous Internal Evaluation Pattern:

Preparing a review article based on peer reviewed original publications (minimum 10 publications shall be referred): 15 marks

Course based task/Seminar/Data collection and interpretation: 15 marks

Test paper, 1 no.: 10 marks

Test paper shall include minimum 80% of the syllabus.

End Semester Examination Pattern:

The end semester examination will be conducted by the respective College. There will be two parts; Part A and Part B. Part A will contain 5 numerical/short answer questions with 1 question from each module, having 5 marks for each question (such questions shall be useful in the testing of knowledge, skills, comprehension, application, analysis, synthesis, evaluation and understanding of the students). Students should answer all questions. Part B will contain 7 questions (such questions shall be useful in the testing of overall achievement and maturity of the students in a course, through long answer questions relating to theoretical/practical knowledge, derivations, problem solving and quantitative evaluation), with minimum one question from each module of which student should answer any five. Each question can carry 7 marks.

Note: The marks obtained for the ESE for an elective course shall not exceed 20% over the average ESE mark % for the core courses. ESE marks awarded to a student for each elective course shall be normalized accordingly. For example, if the average end semester mark % for a core course is 40, then the maximum eligible mark % for an elective course is $40 + 20 = 60\%$.

Model Question Paper

QP CODE:

RegNo:.....

Name:.....

**APJ ABDUL KALAM TECHNOLOGICAL UNIVERSITY SECOND SEMESTER
M.TECH DEGREE EXAMINATION (MONTH & YEAR)**

Course Code: 222ECE045

ENGINEERING FRACTURE MECHANICS

Max. Marks: 60

Duration: 2.5 hours

PART A

(Answer ALL questions)

1. Discuss the historic overview of fracture mechanics.
2. Define Griffith's theory.
3. Derive the stress intensity of through crack under internal pressure using principle of superposition.
4. Explain plastic zone and plot the plastic zone for plane stress condition
5. State Paris law and its limitations.

PART B

(Answer Any FIVE questions only)

6. Explain Airy's stress function and complex stress function.
7. Derive an equation for elliptical flaw in plate and its importance to fracture.
8. Write short note on (a) Leak before break and (b) Damage tolerance analysis.
9. Path independence of J-integral is not valid for elastic-plastic materials, why?
10. Explain any two Direct & indirect method to measure the fracture parameters.
11. Derive an expression for Irwin's plastic zone correction.
12. Describe the importance of R-curve in fracture analysis.

Syllabus

Module 1

Fundamentals of Fracture Mechanics– Introduction - Modes of failure, examples of structural failures due to fracture, fracture mechanics versus strength of materials

Mechanism of crack growth and fracture, fracture control, Review of elasticity, complex variables, complex Airy stress function

Module 2

Linear Elastic Fracture Mechanics -Elasticity based solutions for an infinite plate with circular hole and with elliptical hole

Stress in infinite plate with crack- Westergaard approach and Mushkelishvile approach, stress intensity factor(SIF), Griffith's theory, strain energy release rate, R-curve

Module 3

Design based on LEFM -Design philosophy, SIF due to complex loading, Application of principle of superposition, critical SIF, Leak before break, damage tolerance analysis

Module 4

Elasto-plastic fracture mechanics -J-integral, Crack tip opening displacement (CTOD), relation between CTOD, K_I and G_I for small scale yielding, Equivalence between CTOD and J,

Module 5

Finite element analysis of cracks in solids -Fracture parameters & determination, Mixed mode crack propagation criteria, Analytical models, Fatigue crack growth models to predict life,

Finite elements in fracture mechanics-isotropic singular elements, extraction of SIF using displacement correlation, Displacement extrapolation, Strain energy release rate

Course Plan

No	Topic	No. of Lectures 38
1	Introduction to fracture mechanics	7
1.1	Modes of failure, examples of structural failures due to fracture, fracture mechanics versus strength of materials,	2
1.2	Column stability versus fracture instability, mechanism of crack growth and fracture, fracture control	2
1.3	Review of elasticity, complex variables, complex Airy stress function	3
2	Linear Elastic Fracture Mechanics	8
2.1	Elasticity based solutions for an infinite plate with circular hole, Elasticity based solutions for an infinite plate with an elliptical hole,	3
2.2	Elasticity based solutions for an infinite plate with crack- Westergaard approach and Mushkelishvile approach, stress intensity factor(SIF),	3
2.3	Griffith's theory, strain energy release rate, R-curve	2
3	Design based on LEFM	6
3.1	Design philosophy, SIF due to complex loading	2
3.2	Application of principle of superposition, critical SIF	3
3.3	Leak before break, damage tolerance analysis	1
4	Elasto-plastic fracture mechanics	8
4.1	Plastic zone size and shape, effective crack length	2
4.2	J-integral – definition, experimental evaluation, numerical evaluation	3
4.3	Cracktip opening displacement (CTOD), relation between CTOD, K_I and G_I for small scale yielding, Equivalence between CTOD and J	3
5	Finite element analysis of cracks in solids	9
5.1	Direct & indirect methods to measure fracture parameters,	2
5.2	Mixed mode crack propagation criteria, Analytical models, empirical models, Fatigue crack growth models, life prediction	3
5.3	Finite elements in fracture mechanics-isotropic singular elements, extraction of SIF using displacement correlation, Displacement extrapolation, Strain energy release rate	4

Reference Books

1.T.L.Anderson, Fracture Mechanics, : Fundamentals and Applications, CRC Press, 3rd Edition

2.D.Broek, Elementary Engineering Fracture Mechanics, MartinusNijhoff publishers.

3.Prashant Kumar, Elements of Fracture Mechanics, Tata McGraw Hill, New Delhi, India

4.Meinhardkuna, Finite Elements in Fracture Mechanics: Theory - Numerics - Applications



APJ ABDUL KALAM
TECHNOLOGICAL
UNIVERSITY

SEMESTER II

INTERDISCIPLINARY ELECTIVE

Estd.



2014

CODE	COURSE NAME	CATEGORY	L	T	P	CREDIT
222ECE097	MECHANICS OF COMPOSITE MATERIALS	INTERDISCIPLINARY ELECTIVE	3	0	0	3

Preamble: Fibre reinforced plastic composite materials are finding wide range of applications in the field of aerospace structures, automobile engineering, offshore structures, maritime structures, ships and civil engineering structures presently due to its outstanding material capabilities such as High strength, low weight, high corrosion resistance, high fatigue strength and faster assembly. The everyday applications of composites in the commercial markets and hence the job opportunities in this field are drastically increasing nowadays. This course will equip the students with the specialist knowledge and skills required by the leading employers in aerospace, marine, automobile, construction and renewable energy industries to design and develop next generation environmental-friendly and structural-efficient advanced lightweight composite materials and components.

Course Outcomes: The COs shown are only indicative. For each course, there can be 4 to 6 COs.

After the completion of the Advanced Composite Structures course the student will be able to

CO 1	Identify the properties of fibre and matrix materials used in commercial composites, as well as some common manufacturing techniques.
CO 2	Explain linear elasticity with emphasis on the difference between layered composite materials and isotropic materials.
CO 3	Apply constitutive equations of composite materials and understand the mechanical behaviour at micro and macro levels.
CO 4	Predict the failure mode and strength of laminated composite structures.
CO 5	Apply the ideas developed in the analysis of composites towards using composites in various fields of engineering.

Mapping of course outcomes with program outcomes

	PO 1	PO 2	PO 3	PO 4	PO 5	PO 6	PO 7
CO 1			3	3	2		
CO 2			3	3	2		
CO 3			3	3	2		
CO 4			3	3	2		
CO 5			3	3	2		

Assessment Pattern

Bloom's Category	End Semester Examination
Remember	15
Understand	15
Apply	25
Analyse	5
Evaluate	-
Create	-

Mark distribution

Total Marks	CIE	ESE	ESE Duration
100	40	60	2.5 hours

Continuous Internal Evaluation Pattern:

Preparing a review article based on peer reviewed original publications (minimum 10 publications shall be referred): 15 marks

Course based task/Seminar/Data collection and interpretation: 15 marks

Test paper, 1 no.: 10 marks

Test paper shall include minimum 70% of the syllabus.

End Semester Examination Pattern:

The end semester examination will be conducted by the respective College. There will be two parts; Part A and Part B. Part A will contain 5 numerical/short answer questions with 1 question from each module, having 5 marks for each question (such questions shall be useful in the testing of knowledge, skills, comprehension, application, analysis, synthesis, evaluation and understanding of the students). Students should answer all questions. Part B will contain 7 questions (such questions shall be useful in the testing of overall achievement and maturity of the students in a course, through long answer questions relating to theoretical/practical knowledge, derivations, problem solving and quantitative evaluation), with minimum one question from each module of which student should answer any five. Each question can carry 7 marks.

Note: The marks obtained for the ESE for an elective course shall not exceed 20% over the average ESE mark % for the core courses. ESE marks awarded to a student for each elective course shall be normalized accordingly. For example, if the

average end semester mark % for a core course is 40, then the maximum eligible mark % for an elective course is $40 + 20 = 60$ %.

Model Question paper

PART A

Answer **all** questions.

All Questions carry **equal** marks

1. How is the mechanical advantage of a composite measured?
2. Write the number of independent elastic constants for three dimensional anisotropic, orthotropic, transversely isotropic and isotropic materials.
3. What is Classical Lamination Theory? Explain its significance in composite analysis.
4. The weight fraction of glass in a glass epoxy composite is 0.8. If the specific gravity of glass and epoxy are 2.5 and 1.2 respectively, find (i) fibre and matrix volume fractions (ii) density of composite?
5. Explain briefly the progressive failure analysis in a composite laminate.

PART B

Answer any **FIVE** questions only

6. Briefly explain the Hooke's law for Anisotropic materials. Derive the stress-strain relation for a material with three planes of reflection and one 90° rotation symmetry
7. (a) Explain any two methods of manufacturing of composite in detail.
(b) Derive the relations connecting the engineering constants and the elements of stiffness and compliance matrices for a specially orthotropic lamina.
8. (a) Calculate the longitudinal modulus and tensile strength of a unidirectional composite containing 60% by volume of carbon fibres ($E_{1f} = 294$ GPa and $\sigma_{1fu} = 5.6$ GPa) in a toughened epoxy matrix ($E_m = 3.6$ GPa and $\sigma_{mu} = 105$ GPa). Compare these values with the experimentally determined values of $E_1 = 162$ GPa and $\sigma_{1u} = 2.94$ GPa. What fraction of load is carried by fibres in the composite?
(b) Explain how to calculate the effective moduli of a composite lamina in terms of its constituent properties.
9. (a) Explain the free edge effects and interlaminar stresses in composite laminates
(b) Explain how to determine the laminae stresses and strains from the analysis of a laminate?
10. Calculate the A, B, D matrices for a $[0/90^\circ]$ laminate each layer of which is of 0.125 mm thickness. The lamina properties are given by $E_1 = 140$ GPa, $E_2 = 10$ GPa, $G_{12} = 5$ GPa, $\nu_{12} = 0.3$
11. (a) Explain the effect of interlaminar stresses in composite laminate in detail
(b) Explain the importance of the sign of shear stress on strength of composites.

12. Find the maximum value of $S > 0$ if a stress of $\sigma_x = 2S$, $\sigma_y = -3S$, and $\tau_{xy} = 4S$ is applied to a 60° Graphite/epoxy Lamina. Use Tsai-Hill Failure theory.

Given $(\sigma_1^t)_{ult} = 1500\text{MPa}$, $(\sigma_1^c)_{ult} = 1500\text{MPa}$, $(\sigma_2^t)_{ult} = 40\text{MPa}$, $(\sigma_2^c)_{ult} = 246\text{MPa}$,
 $(\tau_{21})_{ult} = 68\text{MPa}$

Syllabus and Course Plan

No	Topic	No. of Lectures
1	Introduction to Composite Materials (6)	
1.1	Definition of composites, Objectives, constituents and Classification of composites.	2
1.2	Basic terminology used in fibre reinforced composite materials- Lamina, Laminates ,General Characteristics of reinforcement and classifications, Characteristics of matrix- Polymer matrix, Thermoplastics and thermosetting resins, Glass transition temperature , Prepregs	2
1.3	Structural applications of Composite Materials	1
1.4	Processing of Composites	1
2	Macro mechanical behaviour of a composite lamina (9)	
2.1	Review of Basic Equations of Mechanics and Materials, Hooke’s law for different types of materials- Anisotropic, orthotropic, isotropic, monoclinic and Transversely isotropic materials.	2
2.2	Stress-Strain relations for a Two dimensional unidirectional and orthotropic lamina, lamina of arbitrary orientation, Transformations of stress and strain	3
2.3	Relationship of Compliance and stiffness matrix to elastic constants of a lamina	1
2.4	Strength and Failure theories of Continuous Fibre-reinforced orthotropic Lamina- Failure envelopes, Maximum stress/strain criteria, Tsai-Hill and Tsai-Wu criterion.	2
2.5	Hygrothermal stresses and strains in a lamina –unidirectional and angle lamina	1
3	Micromechanical Behaviour of a Lamina (6)	
3.1	Volume and Mass fractions, density and void content	1
3.2	Effective Moduli of a continuous fibre-reinforced lamina – Models based on mechanics of materials, theory of elasticity and experimental methods, Mechanics of materials approach to strength, Numerical Examples	2
3.3	Ultimate Strengths of unidirectional Lamina- longitudinal and transverse tensile and compressive strengths	2
3.4	Coefficients of moisture and thermal expansion	1
4	Macro mechanical behaviour of Laminates (10)	

4.1	Classical Lamination Theory-Laminae Stress-strain behaviour, In-plane forces, stress-strain variation in a laminate, resultant laminate stresses and strains,	3
4.2	Special cases of laminate stiffnesses-symmetric and antisymmetric laminates, cross ply and angle ply laminates, quasi-isotropic laminates	3
4.3	Inplane and flexural modulus of a laminate	1
4.4	Effects of stacking sequence-Laminate code	1
4.5	Free-Edge Interlaminar Effects, Hygro-thermal effects and warpage in a laminate	2
5	Strength and Design of Laminates (9)	
5.1	Determination of laminae stresses and strains, numerical examples	2
5.2	Laminate strength analysis procedure, Failure envelopes	3
5.3	Analysis of laminates after initial failures, Progressive failure Analysis. Numerical Examples	2
5.4	Composite mechanical design issues-Long-term environmental effects, impact resistance, fracture resistance, fatigue resistance	2

Text Books

1. Jones M. Roberts, Mechanics of Composite Materials, Taylor and Francis, 1998
2. Reddy, J.N , Mechanics of Laminated Composite Plates: Theory and Analysis, CRC Press, 2003

Reference Books

1. Calcote, L. R., Analysis of Laminated Composite structures, Van Nostrand, 1969
2. Vinson, J. R. and Chou P, C., Composite materials and their use in Structures, Applied Science Publishers, Ltd. London, 1975
3. Agarwal, B.D. and Broutman, L. J., Analysis and performance of Fibre composites. 3rdEdn.

CODE	COURSE NAME	CATEGORY	L	T	P	CREDIT
222ECE098	PROJECT EVALUATION AND MANAGEMENT	INTERDISCIPLINARY ELECTIVE	3	0	0	3

Preamble: Objective of the course is to enable the students to understand the management aspects of project idea formulations, feasibility studies and report preparation, costing of project, project appraisal and project funding.

Course Outcomes: The COs shown are only indicative. For each course, there can be 4 to 6 COs.

After the completion of the course the student will be able to

CO 1	To develop project ideas
CO 2	To do the feasibility analysis of projects
CO 3	To plan and arrive at Project Costs
CO 4	To carry out project appraisals
CO 5	To identify the various funding sources and select the apt source

Mapping of course outcomes with program outcomes

	PO 1	PO 2	PO 3	PO 4	PO 5	PO 6	PO 7
CO 1	2		3	2		2	
CO 2	2		2				
CO 3	3	2		3			
CO 4	2		2	2	2		
CO 5	2		2	1			

Assessment Pattern

Bloom's Category	End Semester Examination
Understand	20
Apply	10
Analyse	10
Evaluate	20
Create	

Mark distribution

Total Marks	CIE	ESE	ESE Duration
100	40	60	2.5 hours

Continuous Internal Evaluation Pattern:

Preparing a review article based on peer reviewed

Original publications (minimum 10 publications shall be referred) : 15 marks

Course based task/Seminar/Data collection and interpretation : 15 marks

Test paper, 1 no. : 10 marks

Test paper shall include minimum 80% of the syllabus.

End Semester Examination Pattern:

The end semester examination will be conducted by the respective College. There will be two parts; Part A and Part B. Part A will contain 5 numerical/short answer questions with 1 question from each module, having 5 marks for each question (such questions shall be useful in the testing of knowledge, skills, comprehension, application, analysis, synthesis, evaluation and understanding of the students). Students should answer all questions. Part B will contain 7 questions (such questions shall be useful in the testing of overall achievement and maturity of the students in a course, through long answer questions relating to theoretical/practical knowledge, derivations, problem solving and quantitative evaluation), with minimum one question from each module of which student should answer any five. Each question can carry 7 marks. Note: The marks obtained for the ESE for an elective course shall not exceed 20% over the average ESE mark % for the core courses. ESE marks awarded to a student for each elective course shall be normalized accordingly. For example if the average end semester mark % for a core course is 40, then the maximum eligible mark % for an elective course is $40+20 = 60\%$.

Estd.



2014

Model Question Paper

Model Question paper

Course Code & Name:

Project Evaluation and Management

Max. Marks: 60

Duration: 2.5 hours

PART A

(Answer all Questions: Each question carries 5 marks)

1. Discuss the need for project idea generation ?
2. Why feasibility studies are essential?
3. What do you understand by Present value of a single amount?
4. Explain the international practice of Project Appraisal.
5. Discuss the means of Project Financing.

PART B

(Answer any *five* questions: Each carries 7 marks)

6. Describe the various steps involved in Project Identification.
7. How will you assess the technical feasibility of a project?
8. Explain cash flow and what are the benefits of cash flow statement..
9. Discuss the various methods of Risk Analysis
10. Bluebell Enterprises had invested Rs.2,00,00,000 for the purpose of replacing some of its machinery components. This renovation is expected to result in incremental benefits of Rs.5000000 in 1st year, Rs.3000000 in 2nd year and Rs. 4000000 in 3rd year. Calculate the benefit-cost ratio of the replacement project if the applicable discounting rate is 5%..
11. Discuss the role of various institutions for project financing
12. Discuss the Private Sector Participation on Infrastructure Projects in India

Syllabus and Course Plan (For 3 credit courses, the content can be for 40 hrs and for 2 credit courses, the content can be for 26 hrs. The audit course in third semester can have content for 30 hours).

No	Topic	No. of Lectures
1	Project formulation	
1.1	Concepts of Project, Capital Investments	2
1.2	Purpose and need for Project Identification	2
1.3	Methodology for Project Identification	2
1.4	Steps in Project Identification	2
2	Project Feasibility	
2.1	Introduction to feasibility Studies, need for feasibility studies	2
2.2	Components of Feasibility Analysis - Market, Technical, Financial, Economic	4
2.3	Feasibility Reports and approvals	2
3	Project Costing	
3.1	Time Value of Money - Future value of single amount, Present value of single amount, Future value of an annuity, Present value of an annuity, Simple interest-Compound interest	3
3.2	Project Cash Flows	3
3.3	Cost of capital	2
4	Project Appraisal	
4.1	Investment Criteria- Discounting criteria-Net present value (NPV), Benefit cost ratio(BCR), internal rate of return(IRR)- Non-Discounting criteria - Pay Back Period, Accounting rate of return(ARR)	4
4.2	Indian and International Practice of Appraisal	2
4.3	Methods of Analysis of Risk	2
5	Project Financing	
5.1	Project Financing – Means of Finance	2
5.2	Financial Institutions, schemes	3
5.3	Private sector participation in Infrastructure Development Projects - BOT, BOLT, BOOT	2
5.4	Technology Transfer and Foreign Collaboration	1

Reference Books

- 1 Project Planning Analysis selection financing Implementation and Review- Tata Mc Graw Hill Publication, 7th edition 2010, Prasana Chandra
- 2 United Nations Industrial Development Organization (UNIDO) Manual for the preparation of Industrial Feasibility Studies, (IDSI Reproduction), Bombay, 2007.

- 3 A Systems Approach to Planning, Scheduling, and Controlling Project Management Harold Kerzner (2013), Wiley India, New Delhi
- 4 Project planning scheduling & control, James P.Lawis, Meo Publishing Company 2001
- 5 Project planning analysis selection implementation & review Prasanna Chandra, ISBN0-07-462049-5 2002.

APJ ABDUL KALAM
TECHNOLOGICAL
UNIVERSITY



APJ ABDUL KALAM
TECHNOLOGICAL
UNIVERSITY

SEMESTER III

KTU



MOOC COURSES

The MOOC course shall be considered only if it is conducted by the agencies namely AICTE/NPTEL/SWAYAM or NITTTR. The MOOC course should have a minimum duration of 8 weeks and the content of the syllabus shall be enough for at least 40 hours of teaching. The course should have a proctored/offline end semester examination. The students can do the MOOC according to their convenience, but shall complete it by third semester. The list of MOOC courses will be provided by the concerned BoS if at least 70% of the course content match with the area/stream of study. The course shall not be considered if its content has more than 50% of overlap with a core/elective course in the concerned discipline or with an open elective.

MOOC Course to be successfully completed before the commencement of fourth semester (starting from semester 1). A credit of 2 will be awarded to all students whoever successfully completes the MOOC course as per the evaluation pattern of the respective agency conducting the MOOC.



TEMPLATE FOR SYLLABUS

CODE 223AGE100	ACADEMIC WRITING	CATEGORY	L	T	P	CREDIT
		AUDIT COURSE	3	0	0	NIL

Preamble: Learning academic writing sharpens minds, teaches students how to communicate, and develops their thinking capacities and ability to understand others. Writing is thinking, and every student deserves to be a strong thinker. It can also make them think more carefully about what they write. Showing work to others can help to foster a better culture of learning and sharing among students. It also gives students a sense of how they are contributing to the body of work that makes up an academic subject.

Course Outcomes: The COs shown are only indicative. For each course, there can be 4 to 6 COs.

After the completion of the course the student will be able to

CO 1	Understand the principles of scientific/ academic writing
CO 2	Analyse the technique of scientific writing from the reader's perspective
CO 3	Apply the concepts of setting expectations and laying the progression tracks
CO 4	Evaluate the merits of a title, abstract , introduction, conclusion and structuring of a research paper
CO 5	Justify the need using a project proposal or a technical report
CO 6	Prepare a review paper, an extended abstract and a project proposal

Mapping of course outcomes with program outcomes

\	PO 1	PO 2	PO 3	PO 4	PO 5	PO 6	PO 7
CO 1		3	1				
CO 2		3	1				
CO 3		3	1			2	
CO 4		3	1				
CO 5		3	2	2		2	
CO 6	1	3	3	2		2	

Assessment Pattern

Bloom's Category	End Semester Examination
Apply	40%
Analyse	30%
Evaluate	30%



Mark distribution

Total Marks	CIE	ESE	ESE Duration
100	40	60	2.5 hours

Continuous Internal Evaluation Pattern: 40 marks

Course based task : 15 marks

Seminar/Quiz : 15 marks

Test paper, 1 no. : 10 marks

Test paper shall include minimum 80% of the syllabus.

End Semester Examination Pattern: 60 marks

The examination will be conducted by the respective College. The examination will be for 150 minutes and will contain 7 questions, with minimum one question from each module of which student should answer any five. Each question can carry 12 marks.

Model Question paper

		SET1	Total Pages:
Reg No.: _____			Name: _____
APJ ABDUL KALAM TECHNOLOGICAL UNIVERSITY THIRD SEMESTER M.TECH DEGREE EXAMINATION, MARCH 2024			
Course Code: 223AGE100			
Course Name: Academic Writing			
Max. Marks: 60			Duration: 2.5 Hours
<i>Answer any five full questions, each carries 12 marks.</i>			
1 a)	Make clear-cut distinctions between 6 factors that take their toll on readers' memory.		6
1 b)	How can you sustain the attention of the reader to ensure continuous reading?		6
2 a)	What are the different methods by which you can create expectations in the reader?		6
2 b)	Give an account of the topic and non-topic based progression schemes.		6
3 a)	Bring out the differences between an abstract and the introduction of a research paper.		8
3 b)	How are the title of the research paper and its structure related?		4
4	What are 7 principles for including visuals in your research paper. What are the recommended constituents of a conclusion segment of a research paper?		12



5	Give a detailed description of the process and contents of a project proposal for funding.	12
6 a)	What are the contexts recommended for choosing between active and passive voices in technical writing?	8
6 b)	What are the different visual forms that are relevant in a research paper and how do you choose them?	4
7	Give the design of a research paper with the purposes each part serves.	12

Syllabus and Course Plan (For 3 credit courses, the content can be for 40 hrs and for 2 credit courses, the content can be for 26 hrs. The audit course in third semester can have content for 30 hours).

Syllabus:

CODE 223AG E100	ACADEMIC WRITING	Audit
Module No.	Topics in a module	Hours
1	Fundamentals of Academic writing from a reader's perspective: acronyms, synonyms, pronouns, disconnected phrases, background ghetos, abusive detailing, cryptic captions, long sentences : all that take their toll on readers' memory.	6
2	Fluid reading & reading energy consumption: setting expectations and laying Progression tracks; Reading energy consumption	6
3	How to write the Title, abstract, introduction ; Structure the writing with headings & subheadings	6
4	Visuals: Resources, Skills, and Methods; Conclusion; References; Bibliography; Grammar in technical writing	6
5	Techniques of writing: An extended abstract, a project proposal, a research paper, a technical report.	6

Course Plan:

No	Topic	No. of Lectures
1	Fundamentals of Academic writing from a reader's perspective: acronyms, synonyms, pronouns, disconnected phrases, background ghetos, abusive detailing, cryptic captions, long sentences all take their toll on readers' memory.	
1.1	The Reading tool-kit to reduce memory required; reduce reading time	1
1.2	Acronyms, Pronouns, Synonyms; Background, broken couple, words overflow	1
1.3	Sustain attention: Keep the story moving forward; Twists, shouts, Pause to clarify, recreate suspense	2



1.4	Keep the reader motivated: Fuel and meet Expectations; Bridge knowledge gap: ground level; Title words; Just In Time to local background	2
2	Fluid reading & reading energy consumption: setting expectations and laying Progression tracks; Reading energy consumption	
2.1	Setting expectations of the reader from Grammar, from theme	1
2.2	Progression tracks for fluid reading: Topic & stress; topic and non topic based progression tracks; pause in progression	2
2.3	Detection of sentence fluidity problems: No expectations/ Betrayed expectations	2
2.4	Controlling reading energy consumption: the energy bill; Energy fuelling stations: Pause	1
3	How to write the Title, abstract, introduction ; Structure the writing with headings & subheadings	
3.1	Title: Face of the paper: Techniques, Qualities & Purpose of title; Metrics	1
3.2	Abstract: Heart of the paper: 4 parts; coherence; tense of verbs, precision; purpose & qualities of the abstract; Metrics	2
3.3	Structure: Headings & sub-headings: Skeleton of the paper: principles for a good structure; Syntactic rules; Quality & Purpose of structures; Metrics	1
3.4	Introduction: Hands of the paper: Start, finish; scope, definitions; answers key reader questions; As a personal active story; Traps, qualities; Metrics	2
4	Visuals: Resources, Skills, and Methods; Conclusion; References; Bibliography; Grammar in technical writing	
4.1	Visuals as the voice of your paper: principles; purpose & qualities of visuals; metrics	2
4.2	Conclusion: contents; purpose, quality; metrics; Abstracts Vs. Conclusion; examples, counter-examples	1
4.3	References, Bibliography: Styles, punctuation marks, quotes, citations	1
4.4	Grammar in Technical writing: Articles, Syntax, Main and subordinate clauses; Active & passive voices; some commonly made mistakes in technical writing.	2
5	Techniques of writing: An extended abstract, a project proposal, a research paper, a technical report.	
5.1	Extended abstract: abstract and keywords, introduction and objective, method, findings and argument, conclusion and suggestions and references.	1
5.2	Project Proposal:Types, executive summary, background including status, objectives, solution, milestones, deliverables, timelines, resources, budgeting, conclusion	2
5.3	Research paper: writing an overview article: provide a comprehensive foundation on a topic; explain the current state of knowledge; identify gaps in existing studies for potential future research; highlight the main methodologies and research techniques	2



5.4	Writing Technical Reports: Title page; Summary; Table of contents; Introduction; Body; Figures, tables, equations and formulae; Conclusion; Recommendations.	1
		30

Reference Books

1. SCIENTIFIC WRITING 2.0 A Reader and Writer's Guide: Jean-Luc Lebrun, World Scientific Publishing Co. Pte. Ltd., 2011
2. How to Write and Publish a Scientific Paper: Barbara Gastel and Robert A. Day, Greenwood publishers, 2016
3. Grammar, Punctuation, and Capitalisation; a handbook for technical writers and editors. www.sti.nasa.gov/publish/sp7084.pdf www.sti.nasa.gov/sp7084/contents.html
4. Everything You Wanted to Know About Making Tables and Figures. [http://abacus.bates.edu/%7Eganderso/biology/resources/writing/ HTWtableVigs.html](http://abacus.bates.edu/%7Eganderso/biology/resources/writing/HTWtableVigs.html)



223AGE001	ADVANCED ENGINEERING MATERIALS	CATEGORY	L	T	P	CREDIT
		AUDIT COURSE	3	0	0	-

Preamble: This course is designed in a way to provide a general view on typically used advanced classes of engineering materials including metals, polymers, ceramics, and composites.

Course Outcomes: After the completion of the course the student will be able to

CO 1	Analyse the requirement and find appropriate solution for use of materials.
CO 2	Differentiate the properties of polymers, ceramics and composite materials.
CO 3	Recognize basic concepts and properties of functional materials.
CO 4	Comprehend smart and shape memory materials for various applications.
CO 5	Appraise materials used for high temperature, energy production and storage applications.

Mapping of course outcomes with program outcomes

	PO 1	PO 2	PO 3	PO 4	PO 5	PO 6	PO 7
CO 1	<input type="checkbox"/>				<input type="checkbox"/>	<input type="checkbox"/>	
CO 2	<input type="checkbox"/>				<input type="checkbox"/>	<input type="checkbox"/>	
CO 3	<input type="checkbox"/>				<input type="checkbox"/>	<input type="checkbox"/>	
CO 4	<input type="checkbox"/>				<input type="checkbox"/>	<input type="checkbox"/>	
CO 5	<input type="checkbox"/>				<input type="checkbox"/>	<input type="checkbox"/>	

Assessment Pattern

Bloom's Category	End Semester Examination
Understand	60%
Apply	20%
Analyse	20%

Mark distribution

Total Marks	CIE	ESE	ESE Duration
100	40	60	2.5 hours



Continuous Internal Evaluation Pattern: 40 marks

Course based task : 15 marks

Seminar/Quiz : 15 marks

Test paper, 1 no. : 10 marks

Test paper shall include minimum 80% of the syllabus.

End Semester Examination Pattern: 60 marks

The examination will be conducted by the respective College. The examination will be for 150 minutes and will contain 7 questions, with minimum one question from each module of which student should answer any five. Each question can carry 12 marks.

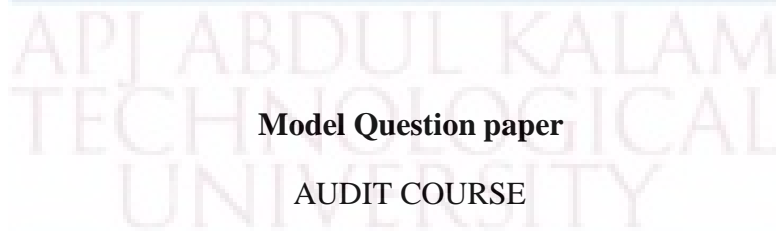

Model Question paper

AUDIT COURSE

223AGE001 - ADVANCED ENGINEERING MATERIALS

(Answer any five questions. Each question carries 12 Marks)

1. a) State the relationship between material selection and processing. 5
b) Write about the criteria for selection of materials with respect to the cost and service requirements for engineering applications. 7
2. a) Differentiate thermosetting and thermoplastics with suitable examples. 5
b) Briefly discuss about the properties and applications of polymer nano composite materials. 7
3. a) Write about the potential application areas of functionally graded materials. 5
b) With a neat sketch describe any one processing technique of functionally graded materials. 7
4. a) “Smart materials are functional”? Justify the statement. 5
b) Explain the terms electrostriction and magnetostriction with its application. 7



5. a) What are the factors influencing functional life of components at elevated temperature? 5
- b) What are super alloys and what are their advantages? 7
- 6 a) What is a shape memory alloy? What metals exhibit shape memory characteristics? 4
- b) Explain about the detection capabilities and uses of pyroelectric sensors. 8
- 7 a) Differentiate between conventional batteries and fuel cells. 4
- b) Explain the construction and working of a Li-ion battery. 8

Syllabus

Module	Content	Hours	Semester Exam Marks (%)
I	Requirements / needs of advanced materials. Classification of materials, Importance of materials selection, Criteria for selection of materials; motivation for selection, cost basis and service requirements. Relationship between materials selection and processing.	5	20
II	Classification of non-metallic materials. Polymer, Ceramics: Properties, processing and applications. Nano Composites - Polymer nanocomposites (PNCs), Processing and characterisation techniques – properties and potential applications.	7	20
III	Functionally graded materials (FGMs), Potential Applications of FGMs, classification of FGMs, processing techniques. limitations of FGMs.	6	20
IV	Smart Materials: Introduction, smart material types - pyroelectric sensors, piezoelectric materials, electrostrictors and magnetostrictors, shape memory alloys – associated energy stimulus and response forms, applications.	5	20
V	High Temperature Materials: super alloys – main classes, high temperature properties of superalloys, applications. Energy Materials: materials for batteries.	7	20



Course Plan

No	Topic	No. of Lectures
1	Selection of materials for engineering applications	
1.1	Benefits of advanced materials, classification of materials, importance of materials selection	2
1.2	Selection of materials for different properties, strength, toughness, fatigue and creep	1
1.3	Selection for surface durability, corrosion and wear resistance	1
1.4	Relationship between materials selection and processing	1
2	Classification of non-metallic materials & nano composites	
2.1	Rubber: properties, processing and applications.	1
2.2	Plastics: thermosetting and thermoplastics, applications and properties.	2
2.3	Ceramics: properties and applications.	1
2.4	Introduction to nano composites, classification	1
2.5	Processing and characterisation techniques applicable to polymer nanocomposites.	2
3	Functionally graded materials	
3.1	General concept, Potential Applications of FGMs	2
3.2	Classification of FGMs	1
3.3	FGMs processing techniques: powder metallurgy route, melt-processing route	2
3.4	Limitations of FGMs	1
4	Smart materials	
4.1	Introduction to smart materials, types	1
4.2	Pyroelectric sensors-material class, stimulus, detection capabilities and uses	1
4.3	Piezoelectric materials- material class, stimulus, sensing and actuating applications	1
4.4	Electrostrictors and magnetostrictors - material class, stimulus, micro positioning capabilities and applications	1
4.5	Shape memory alloys (SMAs) - material class, stimulus, temperature sensing and high strain responses, applications.	1
5	High Temperature Materials and Energy Materials	
5.1	Characteristics of high-temperature materials, superalloys as high-temperature materials	1
	superalloys - properties and applications	2
5.2	Introduction to lithium-ion battery (LIBs), operating mechanisms and applications	2
5.3	Introduction to Zn-based battery system, types and existing challenges	2



Reference Books

1. DeGarmo et al, "Materials and Processes in Manufacturing", 10th Edition, Wiley, 2008.
2. R.E. Smallman and A.H.W. Ngan, Physical Metallurgy and Advanced Materials, Seventh Edition, Butterworth-Heinemann, 2007
3. Vijayamohanan K. Pillai and Meera Parthasarathy, "Functional Materials: A chemist's perspective", Universities Press Hyderabad (2012).
4. M.V. Gandhi, B.S. Thompson: Smart Materials and Structures, Chapman & Hall, 1992.
5. G. W. Meetham and M. H. Van de Voorde, Materials for High Temperature Engineering Applications (Engineering Materials) Springer; 1 edition (May 19, 2000)
6. Inderjit Chopra, Jayant Sirohi, "Smart Structures Theory", Cambridge University Press, 2013



223AGE003	DATA SCIENCE FOR ENGINEERS	CATEGORY	L	T	P	CREDIT
		AUDIT COURSE	3	0	0	0

Preamble: This course covers essentials of statistics and Linear Algebra and how to prepare the data before processing in real time applications. The students will be able to handle missing data and detection of any outliers available in the dataset. This course explores data science, Python libraries and it also covers the introduction to machine learning for engineers.

Course Outcomes: After the completion of the course the student will be able to

CO 1	Study Data Science Concepts and statistics
CO 2	Demonstrate Understanding of Mathematical Foundations needed for Data Science
CO 3	Understand Exploratory analysis and Data Visualization and Preprocessing on given dataset
CO 4	Implement Models such as Naive Bayes, K-Nearest Neighbors, Linear and Logistic Regression
CO 5	Build real time data science applications and test use cases

Mapping of course outcomes with program outcomes

	PO 1	PO 2	PO 3	PO 4	PO 5	PO 6	PO7
CO 1	2		2			2	
CO 2	2		2	1		2	
CO 3	2		2	2	2	2	
CO 4	2		2	2	3	2	
CO 5	2		2	3	3	3	2

Assessment Pattern

Bloom's Category	End Semester Examination
Understand	50%
Apply	30%
Analyse	20%

Mark distribution

Total Marks	CIE	ESE	ESE Duration
100	40	60	2.5 hours



Continuous Internal Evaluation Pattern: 40 marks

Course based task (Project/Assignments/Simulations/Case studies): 15 marks

Seminar/Quiz : 15 marks

Test paper, 1 no. : 10 marks

Test paper shall include minimum 80% of the syllabus.

End Semester Examination Pattern:60 marks

The examination will be conducted by the respective College. The examination will be for 150 minutes and will contain 7 questions, with minimum one question from each module of which student should answer any five. Each question can carry 12 mark.

Syllabus

Module	Content	Hours	Semester Exam Marks (%)
I	Statistics for Data science Probability: Basic concepts of probability, conditional probability, total probability, independent events, Bayes' theorem, random variable, Population, Sample, Population Mean, Sample Mean, Population Distribution, Sample Distribution and sampling Distribution, Mean, Mode, Median, Range, Measure of Dispersion, Variance, Standard Deviation, Gaussian/Normal Distribution, covariance, correlation.	6	20
II	Linear Algebra Vectors and their properties, Sum and difference of Vectors, distance between Vectors, Matrices, Inverse of Matrix, Determinant of Matrix, Trace of a Matrix, Dot Product, Eigen Values, Eigen Vectors, Single Value Decomposition	6	20
III	Hypothesis Testing Understanding Hypothesis Testing, Null and Alternate Hypothesis, Non-directional Hypothesis, Directional Hypothesis Critical Value Method, P-Value Method, Types of Errors-Type1 Error, Type2 Error, Types of Hypothesis Test Z Test, Chi-Square	6	20



IV	Exploratory Data Analysis Data Collection –Public and Private Data, Data Cleaning-Fixing Rows and Columns, Missing Values, Standardizing values, invalid values, filtering data, Data-Integration,Data-Reduction,Data Transformation	6	20
V	Machine Learning and Python for Data Science Python Data structures-List, Tuple, Set, Dictionary, Pandas, Numpy, Scipy, Matplotlib, Machine Learning-Supervised Machine Learning, Unsupervised Machine Learning,Regression, Classification, Naïve-Bayes	6	20

Course Plan

No	Topic	No. of Lectures
1	Statistics for Data science	
1.1	Probability: Basic concepts of probability, conditional probability, total probability	1
1.2	independent events, Bayes' theorem, random variable, Population	1
1.3	Sample, Population Mean, Sample Mean, Population Distribution	1
1.4	Sample Distribution and sampling Distribution, Mean, Mode, Median, Range, Propositional logic and predicate logic	1
1.5	Measure of Dispersion, Variance, Standard Deviation	1
1.6	Gaussian/Normal Distribution, covariance, correlation.	1
2	Linear Algebra	
2.1	Vectors and their properties,	1
2.2	Sum and difference of Vectors, distance between Vectors	1
2.3	Matrices,Inverse of Matrix,	2
2.4	Determinant of Matrix, Trace of a Matrix, Dot Product, Eigen Values, Eigen Vectors, Single Value Decomposition	2
3	Hypothesis Testing	
3.1	Understanding Hypothesis Testing, Null and Alternate Hypothesis	1
3.2	Non-directional Hypothesis, Directional Hypothesis Critical Value Method, P-Value Method,	2
3.3	Types of Errors-Type1 Error, Type2 Error,	1
3.4	Types of Hypothesis Test Z Test, Chi-Square,	2
4	Exploratory Data Analysis	
4.1	Data Collection –Public and Private Data	1
4.2	Data Cleaning-Fixing Rows and Columns	1
4.3	Missing Values	1
4.4	Standardizing values	1
4.5	Invalid values, filtering data	1
4.6	Data Integration, Data Reduction, Data Transformation	1



5	Machine Learning and Python for Data Science	
5.1	Python Data structures-List, Tuple, Set,	1
5.2	Dictionary, Pandas, Numpy, Matplotlib	2
5.3	Machine Learning-Supervised Machine Learning, Unsupervised Machine Learning	1
5.4	Regression, Classification	1
5.5	Naïve-Bayes	1

Reference Books

1. Python Data Science Handbook. Essential Tools for Working with Data, Author(s): Jake VanderPlas, Publisher: O'Reilly Media, Year: 2016
2. Practical Statistics for Data Scientists: 50 Essential Concepts, Author(s): Peter Bruce, Andrew Bruce, Publisher: O'Reilly Media, Year: 2017
3. Practical Linear Algebra for Data Science, by Mike X Cohen, Released September 2022, Publisher(s): O'Reilly Media, Inc.
4. Data Science from Scratch 'by Joel Grus, Released, April 2015, Publisher(s): O'Reilly Media, Inc.
5. Hands-On Exploratory Data Analysis with Python, by Suresh Kumar Mukhiya, Usman Ahmed, Released March 2020, Publisher(s): Packt Publishing



Reg
No.:

Name: _____

APJ ABDUL KALAM TECHNOLOGICAL UNIVERSITY
THIRD SEMESTER M.TECH DEGREE EXAMINATION, MARCH 2024

Course Code: 223AGE003

Course Name: DATA SCIENCE FOR ENGINEERS

Max. Marks: 60

Duration: 2.5 Hours

Answer any five full questions, each carries 12 marks.

- 1 a) It is observed that 50% of mails are spam. There is software that filters spam mail before reaching the inbox. Its accuracy for detecting a spam mail is 99% and chances of tagging a non-spam mail as spam mail is 5%. If a certain mail is tagged as spam find the probability that it is not a spam mail. 5
- b) Depict the relevance of measures of central tendency in data wrangling with a suitable example 7
2. a) Calculate the inverse of the Matrix 4
- | | | |
|---|----|----|
| 2 | 4 | -6 |
| 7 | 3 | 5 |
| 1 | -2 | 4 |
- b) Find all Eigenvalues and Corresponding Eigenvectors for the matrix if 8
- | | | |
|---|----|---|
| 2 | -3 | 0 |
| 2 | -5 | 0 |
| 0 | 0 | 3 |
3. a) A statistician wants to test the hypothesis $H_0: \mu = 120$ using the alternative hypothesis $H_a: \mu > 120$ and assuming that $\alpha = 0.05$. For that, he took the sample values as $n = 40$, $\sigma = 32.17$ and $\bar{x} = 105.37$. Determine the conclusion for this hypothesis? 5
- b) Hypothesis testing is an integral part of statistical inference, list out the various types of hypothesis testing and also mention their significances in data science. 7
4. a) Brief in detail directional and non-directional hypothesis 6
- b) Differentiate null and alternate hypothesis and also elaborate on type 1 and type 2 errors 6
5. a) Explain the concepts of Tuple, List and Directory in python with example 6
- b) Elucidate reinforcement learning and application in real world. 6



6. a) What is Feature Engineering , demonstrate with an example 6
- b) Describe in detail different steps involved in data preprocessing. 6
7. a) Illustrate supervised learning model with linear regression model 5
- b) Predict the probability for the given feature vector if an accident will happen or not? 7

Weather condition: rain, Road condition: good, Traffic condition: normal, Engine problem: no, the task is to predict using Naïve Bayes classification.

SNo.	Weather condition	Road condition	Traffic condition	Engine problem	Accident
1	Rain	bad	high	no	yes
2	snow	average	normal	yes	yes
3	clear	bad	light	no	no
4	clear	good	light	yes	yes
5	snow	good	normal	no	no
6	rain	average	light	no	no
7	rain	good	normal	no	no
8	snow	bad	high	no	yes
9	clear	good	high	yes	no
10	clear	bad	high	yes	yes



223AGE004	DESIGN THINKING	CATEGORY	L	T	P	CREDIT
		AUDIT COURSE	3	0	0	-

Preamble:

This course offers an introductory exploration of fundamental engineering concepts and techniques, the design process, analytical thinking and creativity, as well as the fundamentals and development of engineering drawings, along with their application in engineering problems.

Course Outcomes:

After the completion of the course the student will be able to

CO 1	Identify and frame design challenges effectively.
CO 2	Generate creative ideas through brainstorming and ideation
CO 3	Iterate on designs based on user insights
CO 4	Apply Design Thinking to real-world problems and projects.

	PO 1	PO 2	PO 3	PO 4	PO 5	PO 6	PO 7
CO 1				2		2	2
CO 2	2		2	2			2
CO 3		2		2		2	2
CO 4	2		2	3	2		2

Assessment Pattern

Bloom's Category	End Semester Examination
Apply	40
Analyse	30
Evaluate	30
Create	

Mark distribution

Total Marks	CIE	ESE	ESE Duration
100	40	60	2.5 hours

Continuous Internal Evaluation Pattern:

AUDIT COURSES



Continuous Internal Evaluation Pattern: 40 marks

Course based task : 15 marks

Seminar/Quiz : 15 marks

Test paper, 1 no. : 10 marks

Test paper shall include minimum 80% of the syllabus.

End Semester Examination Pattern: 60 marks

The examination will be conducted by the respective College. The examination will be for 150 minutes and will contain 7 questions, with minimum one question from each module of which student should answer any five. Each question can carry 12 marks.

Model Question paper

		SET1	Total Pages:
Reg No.: _____			Name: _____
APJ ABDUL KALAM TECHNOLOGICAL UNIVERSITY THIRD SEMESTER M.TECH DEGREE EXAMINATION, MARCH 2024			
Course Code: 223AGE004			
Course Name: DESIGN THINKING			
Max. Marks: 60			Duration: 2.5 Hours
<i>Answer any five full questions, each carries 12 marks.</i>			
1 a)	How can a multidisciplinary team collaborate effectively to implement design principles?		7
1 b)	What are the key differences between human-centred design and other design methodologies?		5
2 a)	How do you measure the success of a design project in terms of user satisfaction and impact?		7
2 b)	How does the iterative nature of the design process contribute to better outcomes		5



3 a)	What are the fundamental principles of effective brainstorming, and how do they differ from traditional problem-solving approaches?	7
3 b)	What are some key principles of ergonomic design, and how do they contribute to the usability and comfort of products?	5
4 a)	Enumerate some examples of successful and unsuccessful market testing scenarios, and what lessons can be learned from these experiences to improve future product or service launches?	7
4b)	What is the primary purpose of creating prototypes in the design and development process?	5
5	What strategies and methodologies can designers use to embrace agility and respond quickly to changing user needs and market dynamics?	12
6	Illustrate any four examples of successful bio-mimicry applications in various industries.	12
7	What ethical considerations should designers keep in mind when designing for diverse user groups?	12

2014



Syllabus:

Module 1

Design process: Traditional design, Design Thinking Approach, Introduction to Design Thinking, History and evolution of Design Thinking, Role of design thinking in the human-centred design process. Design space, Design Thinking in a Team Environment, Team formation.

Module 2

Design Thinking Stages: Empathize, Define, Ideate, Prototype and Test. The importance of empathy, Building a user-centred mindset. Problem statement formulation, User needs and pain points, establishing target specifications, Setting the final specifications.

Module 3

Generating Ideas, Brainstorming techniques, Application of Aesthetics and Ergonomics in Design. Bio-mimicry, Conceptualization, Visual thinking, Drawing/Sketching, Presenting ideas.

Module 4

Use of prototyping, Types of prototypes, Rapid prototyping techniques, User testing and feedback collection, Iterative prototyping, testing to gauge risk and market interest

Module 5

Entrepreneurship/business ideas, Patents and Intellectual Property, Agility in design, Ethical considerations in design. Overcoming common implementation challenges

Corse Plan SyllabusandCorsePlan (For 3credit courses, the content can be for 40 hrs and for2credit courses, the content can be for 26 hrs. The audit course in third semester can have content for 30hours).

No	Topic	No. of lectures
1	Design process:	
1.1	Design process: Traditional design, Design Thinking Approach, Introduction to Design Thinking, History and evolution of Design Thinking.	3
1.2	Role of design thinking in the human-centred design process. Design space,	2
1.3	Design Thinking in a Team Environment, Team formation.	2



2	Design Thinking Stages:	
2.1	Design Thinking Stages: Empathize, Define, Ideate, Prototype and Test.	2
2.2	The importance of empathy, Building a user-centred mindset.	2
2.3	Problem statement formulation, User needs and pain points, establishing target specifications, Setting the final specifications.	3
3	Ideation	
3.1	Generating Ideas, Brainstorming techniques.	2
3.2	Application of Aesthetics and Ergonomics in Design. Bio-mimicry.	3
3.3	Conceptualization, Visual thinking, Drawing/Sketching, Presenting ideas.	2
4	Prototyping and testing	
4.1	Use of prototyping, Types of prototypes, Rapid prototyping techniques.	3
4.2	User testing and feedback collection, Iterative prototyping, testing to gauge risk and market interest	2
5	IPR in design	
5.1	Entrepreneurship/business ideas, Patents and Intellectual Property.	2
5.2	Agility in design, Ethical considerations in design. Overcoming common implementation challenges	2

Reference Books

1. Christoph Meinel, Larry Leifer and Hasso Plattner- "Design Thinking: Understand – Improve – Apply", Springer Berlin, Heidelberg, 2011.
2. Thomas Lockwood and Edgar Papke – "Design Thinking: Integrating Innovation, Customer Experience, and Brand Value", Allworth Press, 2009.
3. Pavan Soni – "Design Your Thinking", Penguin Random House India Private Limited, 2020.
4. Andrew Pressman- "Design Thinking : A Guide to Creative Problem Solving for Everyone", Taylor & Francis, 2018.
5. N Siva Prasad, "Design Thinking Techniques an Approaches" Ane Books Pvt. Ltd.,2023



SYLLABUS

CODE	COURSE NAME	CATEGORY	L	T	P	CREDIT
223AGE005	FUNCTIONAL PROGRAMMING IN HASKELL	AUDIT COURSE	3	0	0	-

Preamble: This course introduces a functional programming approach in problem solving. Salient features of functional programming like recursion, pattern matching, higher order functions etc. and the implementation in Haskell are discussed.

Course Outcomes:

After the completion of the course the student will be able to

CO 1	Understand the functional programming paradigm which is based on the mathematics of lambda calculus.
CO 2	Develop Haskell programs using functions, guards and recursive functions
CO 3	Apply the concept of tuples, lists and strings in Haskell programming
CO 4	Apply the concept of algebraic data types, abstract data types, modules, recursive data types and user defined data types in Haskell programming
CO 5	Develop Haskell programs with files for reading input and storing output

Mapping of course outcomes with program outcomes

	PO 1	PO 2	PO 3	PO 4	PO 5	PO 6	PO 7
CO 1					3		
CO 2	2			2	3		
CO 3	2			2	3		
CO 4	2			2	3		
CO 5	2			2	3		

Assessment Pattern

Bloom's Category	End Semester Examination
Apply	40%
Analyse	40%
Evaluate	20%
Create	

Mark distribution

Total Marks	CIE	ESE	ESE Duration
100	40	60	2.5 hours



Continuous Internal Evaluation: 40 marks

Course based task : 15 marks

Seminar/Quiz : 15 marks

Test paper, 1 no. : 10 marks

Test paper shall include minimum 80% of the syllabus.

End Semester Examination: 60 marks

The examination will be conducted by the respective College. The examination will be for 150 minutes and will contain 7 questions, with minimum one question from each module of which student should answer any five. Each question can carry 12 marks.

Model Question paper

		Total Pages:	
Reg No.: _____		Name: _____	
APJ ABDUL KALAM TECHNOLOGICAL UNIVERSITY			
THIRD SEMESTER M.TECH DEGREE EXAMINATION, DECEMBER 2023			
Course Code: 223AGE005			
Course Name: Functional Programming in Haskell			
Max. Marks: 60		Duration: 2.5 Hours	
<i>Answer any five full questions, each carries 12 marks.</i>			
1 a.	Explain the basic differences between imperative style programming and functional style programming.	3	
1 b.	Analyse each of the following lambda expressions to clarify its structure. If the expression is a function, identify the bound variable and the body expression, and then analyse the body expression. If the expression is an application, identify the function and argument expressions, and then analyse the function and argument expressions: i) $\lambda a.(a \lambda b.(b a))$ ii) $\lambda x.\lambda y.\lambda z.((z x) (z y))$ iii) $(\lambda f.\lambda g.(\lambda h.(g h) f) \lambda p.\lambda q.p)$	9	
2 a.	Design a recursive function to find 2^n where n is a natural number.	4	



2 b.	Explain various forms of function definitions in Haskell with the help of examples.	8
3 a.	Explain any three list operations along with function definitions and examples.	6
3 b.	Write a program to duplicate only even numbers among the elements of a list using a Haskell function by (i) Recursion (ii) List Comprehension and explain. Example : $\lambda > \text{dupli } [1, 2, 3]$ ANS: [2,2]	6
4	Write Recursive definitions along with an explanation for the below arithmetic operations. Illustrate the recursive flow with the help of a diagram. i. add x y ii. mult x y iii. div x y	12
5	Write the Haskell code to split a list into two lists such that the elements with odd index are in one list while the elements with even index are in the other list.	12
6 a	Give the type definition of a binary tree along with explanation of two functions on binary trees.	6
6 b	Define a queue data type in Haskell along with any two operations on it with examples.	6
7 a.	Explain the basic steps of reading from files and writing to files in Haskell.	4
7 b.	Write a Haskell program to read from the file "input.txt", display the contents on the screen and write the contents to another file "output.txt".	8

Syllabus and Course Plan (For 3 credit courses, the content can be for 40 hrs and for 2 credit courses, the content can be for 26 hrs. The audit course in third semester can have content for 30 hours).

Module 1 (5 Hrs)

Introduction to Functional Programming: Programming language paradigms, imperative style programming, comparison of programming paradigms.

Functional programming, Functions - Mathematical concepts and terminology, Lambda calculus, Function definitions, programs as functions, Functional programming Languages. Haskell basics, GHCi interpreter.



Module 2 (6 Hrs)

Programming in Haskell: Expressions and evaluation, Lazy evaluation, let expressions, scopes.

Basic data types in Haskell, operators, infix operators, associativity and precedence, Arithmetic functions.

types, definitions, currying and uncurrying, type abstraction.

Function definitions, pattern matching, guards, anonymous functions, higher order functions.

Recursion, Programming exercises.

Module 3 (7 Hrs)

Data types: tuples and lists: Tuples , Lists: building lists, decomposing lists, functions on lists, built-in functions on lists, primitive and general recursion over lists, infinite lists.

Strings: functions on strings.

Polymorphism and overloading, conditional polymorphism

Module 4 (6 Hrs)

Type classes, Algebraic data types, Modules, Recursive data types.

User defined data types, Records, Stacks, Queues, Binary trees, Constructors, Destructors.

Module 5 (6 Hrs)

Functor, Applicative functor, Monad

Programming with actions: Functions vs actions, Basics of input / output, the do notation, interacting with the command line and lazy I/O, File I/O.

No	Topic	No. of Lectures
1	Introduction to Functional Programming	
1.1	Programming language paradigms, imperative style programming, comparison of programming paradigms	1
1.2	Functional programming, Functions - Mathematical concepts and terminology	1
1.3	Lambda calculus	1
1.4	Function definitions, programs as functions, Functional programming Languages	1
1.5	Haskell basics, GHCi interpreter	1
2	Haskell basics	
2.1	Expressions and evaluation, Lazy evaluation	1
2.2	let expressions, scopes, Basic data types in Haskell	1
2.3	operators, infix operators, associativity and precedence, Arithmetic	1



	functions	
2.4	types, definitions, currying and uncurrying, type abstraction.	1
2.5	Function definitions, pattern matching, Guards	1
2.6	anonymous functions, higher order functions, Recursion	1
3	Data types: tuples and lists	
3.1	Tuples , Lists: building lists, decomposing lists	1
3.2	functions on lists, built-in functions on lists	1
3.3	primitive and general recursion over lists	1
3.4	infinite lists	1
3.5	Strings: functions on strings	1
3.6	Polymorphism and overloading	1
3.7	conditional polymorphism	1
4	User defined data types	
4.1	Type classes, Algebraic data types, Modules	1
4.2	Recursive data types	1
4.3	User defined data types, Records	1
4.4	Stacks, Queues	1
4.5	Binary trees	1
4.6	Constructors, Destructors	1
5	Programming with actions	
5.1	Functor, Applicative functor,	1
5.2	Monad	1
5.3	Programming with actions: Functions vs actions, Basics of input / output, the do notation	1
5.4	interacting with the command line and lazy I/O	1
5.5	File I/O	2

Reference Books

[1] Richard Bird, "Introduction to functional programming using Haskell", second edition, Prentice hall series in computer science

[2] Bryan O'Sullivan, Don Stewart, and John Goerzen, "Real World Haskell"



- [3] Richard Bird, “Thinking Functionally with Haskell”, Cambridge University Press, 2014
- [4] Simon Thompson, “Haskell: The Craft of Functional Programming”, Addison-Wesley, 3rd Edition, 2011
- [5] H. Conrad Cunningham, “Notes on Functional Programming with Haskell”, 2014
- [6] Graham Hutton, “Programming in Haskell”, Cambridge University Press, 2nd Edition, 2016
- [7] Alejandro Serrano Mena, “Practical Haskell: A Real-World Guide to Functional Programming”, 3rd Edition, Apress, 2022
- [8] Miran Lipovaca, “Learn You a Haskell for Great Good!: A Beginner's Guide”, No Starch Press, 2011

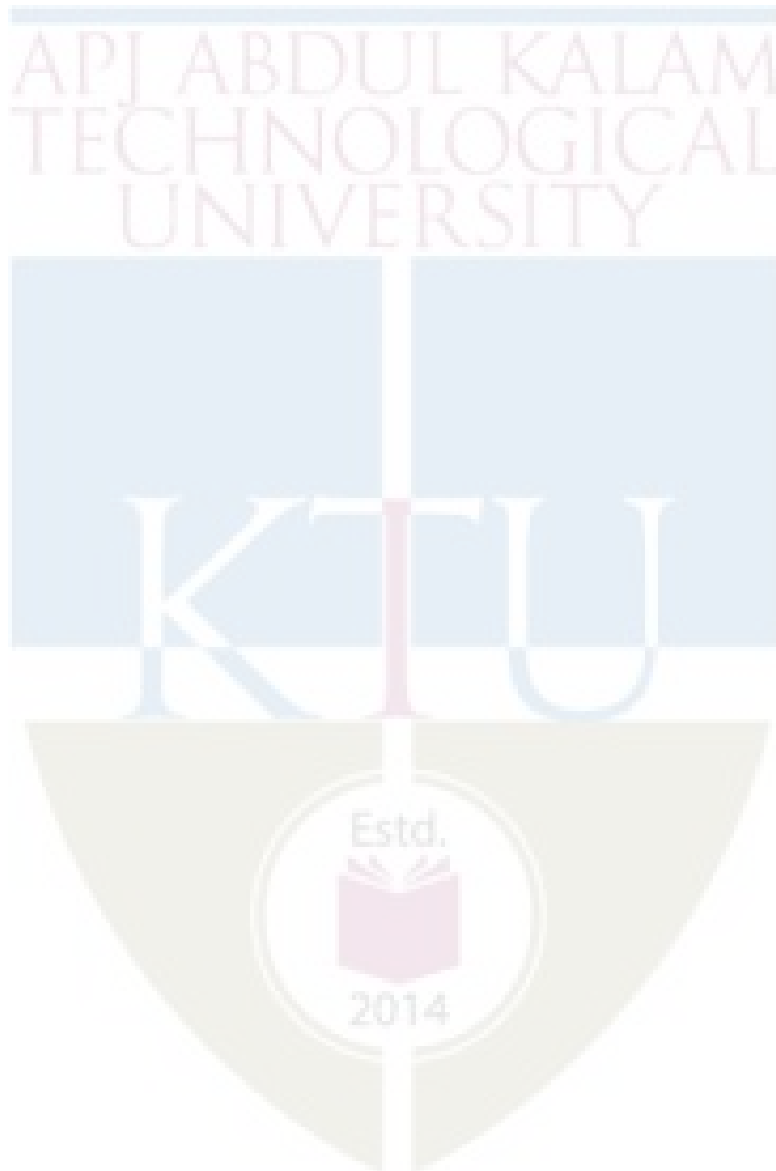

223AGE010	REUSE AND RECYCLE TECHNOLOGY	CATEGORY	L	T	P	CREDIT
		AUDIT COURSE	3	0	0	-

Preamble: "Reuse and Recycle Technology" typically focuses on sustainable practices and technologies aimed at reducing waste, conserving resources, and promoting environmental responsibility.

Course Outcomes: After the completion of the course the student will be able to

CO 1	Explain the principles and technologies behind waste reduction, resource conservation, and sustainable practices
CO 2	Describe and Analyze waste generation and management.
CO 3	Apply the knowledge of various reuse strategies and their application in different industries and Analyze various recycling technologies
CO 4	Appraise the methods of E-waste management and Eco friendly packaging
CO 5	Comprehend Environmental Regulations and Policies, Understand the importance of environmental regulations and policies in addressing environmental challenges

Mapping of course outcomes with program outcomes

	PO 1	PO 2	PO 3	PO 4	PO 5	PO 6
CO 1			3			
CO 2				3		
CO 3				3		
CO 4					3	
CO 5			3			

Assessment Pattern

Bloom's Category	End Semester Examination
Understand	60%
Apply	20%
Analyse	20%

Mark distribution

Total Marks	CIE	ESE	ESE Duration
100	40	60	2.5 hours



Continuous Internal Evaluation Pattern: 40 marks

Course based task : 15 marks

Seminar/Quiz : 15 marks

Test paper, 1 no. : 10 marks

Test paper shall include minimum 80% of the syllabus.

End Semester Examination Pattern: 60 marks

The examination will be conducted by the respective College. The examination will be for 150 minutes and will contain 7 questions, with minimum one question from each module of which student should answer any five. Each question can carry 12 marks.

Model Question paper

AUDIT COURSE

223AGE010 - REUSE AND RECYCLE TECHNOLOGY

Answer any five full questions, each carries 12 marks.

1.	(a) What are the 3 pillars of sustainability?	5
	(b) What is sustainable waste management? What makes sustainable waste management so important?	7
2.	(a) How do the three categories of municipal solid waste differ?	5
	(b) Discuss the municipal waste collection and management?	7
3.	(a) Explain the major differences between Reuse and Recycle?	5
	(b) Give an overview of recycling technologies used for any two materials. Discuss the Process involved.	7
4.	(a) What are the common source of E-waste	5
	(b) What are the challenges and opportunities in E-waste management	7
5.	(a) What is the case law for waste recycling in India	5
	(b) Discuss sustainable packaging and its environmental impacts	7
6.	Explain the various environmental regulations in India for addressing Environmental challenges	12
7.	a) Give examples of water reuse technologies in circular economy	5
	b) How can we reduce e-waste with sustainable solutions	7



Syllabus

Module	Content	Hours	Semester Exam Marks (%)
I	Introduction to Sustainability , Understanding sustainability and its importance, The three pillars of sustainability: Environmental, Social, and Economic. Biodiversity conservation, Climate change and mitigation Sustainable resource management.	6	20
II	Waste Management , Definition and classification of waste, Waste Generation and Composition, Waste Collection and Transportation, Waste Segregation and Sorting. Waste Disposal Methods Historical perspectives on waste management, The three Rs: Reduce, Reuse, and Recycle.	6	20
III	Recycling and Reuse: Importance of reuse, Application of reuse in various industries, Challenges and opportunities in reuse, Overview of recycling technologies, Circular economy, Sorting and processing of recyclable materials, Advanced recycling methods. Emerging technologies in recycling.	6	20
IV	E-waste Recycling , Challenges and environmental impact of electronic waste, E-waste recycling methods and regulations, Sustainable electronics design, Sustainable Packaging , Packaging materials and their environmental impact, Eco-friendly packaging alternatives, Packaging design for sustainability	6	20
V	Environmental Regulations and Policies , Understand the importance of environmental regulations and policies in addressing environmental challenges, National and international waste and recycling regulations, Compliance and enforcement, Industry standards and certifications	6	20

Course Plan



No	Topic	No. of Lectures
1	Introduction to Sustainability (6)	
1.1	Understanding sustainability and its importance	1
1.2	The three pillars of sustainability: Environmental, Social, and Economic.	3
1.3	Biodiversity conservation, Climate change and mitigation	1
1.4	Sustainable resource management	1
2	Waste Management (6)	
2.1	Definition and classification of waste	1
2.2	Waste Generation and Composition	1
2.3	Waste Collection and Transportation.	1
2.4	Waste Segregation and Sorting.	1
2.5	Waste Disposal Methods	1
2.6	Historical perspectives on waste management, The three Rs: Reduce, Reuse, and Recycle.	1
3	Recycling and Reuse (6)	
3.1	Importance of reuse, Examples of reuse in various industries.	1
3.2	Challenges and opportunities in reuse	1
3.3	Overview of recycling technologies, Sorting and processing of recyclable materials	2
3.4	Advanced recycling methods	1
3.5	Emerging technologies in recycling.	1
4	E-waste Recycling (6)	
4.1	Challenges and environmental impact of electronic waste	1
4.2	E-waste recycling methods and regulations	1
4.3	Sustainable electronics design	1
4.4	Packaging materials and their environmental impact	1
4.5	Eco-friendly packaging alternatives	1
4.6	Packaging design for sustainability	1
5	Environmental Regulations and Policies (6)	
5.1	Importance of environmental regulations and policies in addressing environmental challenges	2
5.2	National and international waste and recycling regulations	2
5.3	Industry standards and certifications, Compliance and enforcement	2



Reference Books

1. Sustainable Engineering: Concepts, Design and Case Studies, David T. Allen, Pearson Publication.
2. A Comprehensive Book on Solid Waste Management with Application, Dr. H.S. Bhatia , Misha Books, 2019
3. "Cradle to Cradle: Remaking the Way We Make Things" by William McDonough and Michael Braungart.
4. "Recycling of Plastic Materials" edited by Vijay Kumar Thakur
5. E-waste: Implications, Regulations and Management in India and Current Global Best Practices, Rakesh Johri, TERI
6. "Sustainable Packaging", Subramanian Senthilkannan Muthu , Springer Nature.
7. Indian Environmental Law: Key Concepts and Principles " Orient Black swan Private Limited, New Delhi.



223AGE012	EXPERT SYSTEMS	CATEGORY	L	T	P	CREDIT
		AUDIT COURSE	3	0	0	-

Preamble: The course aims to provide an understanding of the basic concepts of Artificial Intelligence (AI) and Expert Systems. The course also covers the knowledge representation in expert systems, classes of expert systems, applications of expert systems.

Course Outcomes: After the completion of the course the student will be able to:

CO 1	Explain the concepts of Artificial Intelligence and different ways of knowledge representations.
CO 2	Explain the components of expert systems, development stages of expert systems and tools available for expert system design.
CO 3	Apply the concept of knowledge representation in expert systems
CO 4	Differentiate the classes of expert systems and examine properties of existing systems

Mapping of course outcomes with program outcomes

	PO 1	PO 2	PO 3	PO 4	PO 5	PO 6	PO7
CO 1	1		2	1	2	2	
CO 2	1		1	3	2	2	
CO 3	1		1	2	2	2	
CO 4	2		2	2	3	2	

Assessment Pattern

Bloom's Category	End Semester Examination
Understand	60%
Apply	20%
Analyse	20%

Mark distribution

Total Marks	CIE	ESE	ESE Duration
100	40	60	2.5 hours

Continuous Internal Evaluation Pattern: 40 marks

Course based task (Project/Assignments/Simulations/Case studies): 15 marks

Seminar/Quiz : 15 marks

Test paper, 1 no. : 10 marks

Test paper shall include minimum 80% of the syllabus.



End Semester Examination Pattern:60 marks

The examination will be conducted by the respective College. The examination will be for 150 minutes and will contain 7 questions, with minimum one question from each module of which student should answer any five. Each question can carry 12 mark.

APJ ABDUL KALAM TECHNOLOGICAL UNIVERSITY		
THIRD SEMESTER M.TECH DEGREE EXAMINATION, MARCH 2024		
Course Code: 223AGE012		
Course Name: EXPERT SYSTEMS		
Max. Marks: 60		Duration: 2.5 Hours
<i>Answer any five full questions, each carries 12 marks.</i>		
1	a) What are the types of AI? Explain with examples .	6
	b) What do you mean by knowledge in AI and explain the different ways of knowledge representation used in AI?	6
2.	a) Write note on semantic network.	6
	b) What are Predicates? Explain its syntax and semantics.	6
3.	a) Write notes on different tools available for expert system design.	6
	b). What are the different stages in the development of an expert system?	6
4.	a) Illustrate Conceptual Dependencies with an example.	6
	b) Illustrate with an example the Structured Knowledge representation of an Expert System.	6
5.	a) What do you mean by Frame based Expert System? Explain	6
	b) Explain the architecture of MYCIN	6
6.	a) Explain Fuzzy based expert systems	6
	b) Explain the neural network based expert systems	6
7.	a) Explain any two applications of expert systems?	6
	b) What are the limitations of expert system ? Explain	6



Syllabus

Module	Content	Hours	Semester Exam Marks (%)
I	<p>Overview of Artificial Intelligence (AI): Definition & Importance of AI.</p> <p>Knowledge general concepts: Definition and Importance of knowledge, Knowledge-Based Systems, Knowledge organization, Knowledge Manipulation and acquisition.</p> <p>Knowledge Representation: Introduction, Syntax and Semantics- Propositional logic and predicate logic.</p>	6	20
II	<p>Basic concepts of expert systems-Introduction to expert systems, Components of expert systems. Features of Expert System, Stages in the development of expert system, Types of tools available for expert system design</p>	6	20
III	<p>Knowledge representation in expert systems: Structured Knowledge representation: Graphs, Frames and related structures, Associative networks, Conceptual dependencies, Examples of structured knowledge representation.</p>	6	20
IV	<p>Classes of expert systems: Rule-based expert systems, Example- MYCIN, Frame-based expert system, terminologies, IF-THEN structure. Fuzzy and Neural network based expert systems(basic concepts)</p>	7	20
V	<p>Currents trends in expert systems, Advantages and limitations of expert systems, Applications of expert systems.</p>	5	20



Course Plan

No	Topics	No. of Lectures
1	Overview of Artificial Intelligence& Knowledge general concepts	
1.1	Definition & Importance of AI	1
1.2	Definition and Importance of Knowledge,	1
1.3	Knowledge-Based Systems, Knowledge Organization	1
1.4	Knowledge Manipulation and acquisition	1
1.5	Knowledge Representation: Introduction, Syntax and Semantics	1
1.6	Propositional logic and predicate logic	1
2	Basic concepts of expert systems	
2.1	Introduction to Expert System, Components of expert systems	2
2.2	Features of Expert System, Stages in the development of expert system	2
2.3	Types of tools available for expert system design	2
3	Knowledge representation in expert systems	
3.1	Structured Knowledge representation	1
3.2	Graphs, Frames and Related Structures	2
3.3	Associative Networks, Conceptual Dependencies	2
3.4	Examples of structured knowledge representation	1
4	Classes of expert systems	
4.1	A rule-based expert system -Introduction	1
4.2	MYCIN	1
4.3	IF-THEN structure	1
4.4	Frame-based expert system	2
4.5	Fuzzy based expert systems	1
4.6	Neural network based expert systems	1
5	Currents trends and applications of expert systems	
5.1	Currents trends of expert systems	2
5.2	Advantages and limitations of expert systems	1
5.3	Applications of expert systems	2

Reference Books

1. E. Rich & K. Knight - Artificial Intelligence, 2/e, TMH, New Delhi, 2005.
2. P.H. Winston - Artificial Intelligence, 3/e, Pearson Edition, New Delhi, 2006.
3. D.W. Rolston - Principles of AI & Expert System Development, TMH, New Delhi
4. Kevin Night and Elaine Rich, Nair B., "Artificial Intelligence (SIE) ", McGraw Hill – 2010
5. Dan W Patterson, 'Introduction to Artificial intelligence and Expert systems', Prentice Hall of India Pvt. Ltd,2007
6. Russel (Stuart), 'Artificial Intelligence- Modern approach, Pearson Education series in AI', 3rd Edition, 2009.
7. I. Gupta, G. Nagpal · Artificial Intelligence and Expert Systems, Mercury Learning and Information -2020



223AGE011	SYSTEM MODELLING	CATEGORY	L	T	P	CREDIT
		AUDIT COURSE	3	0	0	-

Preamble: Study of this course provides the learners a clear understanding of fundamental concepts in simulation and modelling. This course covers the different statistical models, importance of data collection and various types of simulations. The course helps the learners to find varied applications in engineering, medicine and bio-technology.

Course Outcomes: After the completion of the course the student will be able to

CO 1	Analyse the requirement and find appropriate tool for simulation.
CO 2	Differentiate the different statistical models.
CO 3	Discuss the different techniques for generating random numbers.
CO 4	Analyse the different methods for selecting the different input models..
CO 5	Discuss the different measures of performance and their estimation

Mapping of course outcomes with program outcomes

	PO 1	PO 2	PO 3	PO 4	PO 5	PO 6
CO 1	2		1	1	2	
CO 2	2		1	1	1	
CO 3	1					
CO 4	1		1	1		
CO 5	2		1	1	1	

Assessment Pattern

Bloom's Category	End Semester Examination
Understand	60%
Apply	20%
Analyse	20%

Mark distribution

Total Marks	CIE	ESE	ESE Duration
100	40	60	2.5 hours

Continuous Internal Evaluation Pattern:

Course based task (Project/Assignments/Simulations/Case studies): 15 marks

Seminar/Quiz: 15 marks

Test paper, 1 no.: 10 marks

Test paper shall include minimum 80% of the syllabus.



End Semester Examination Pattern:

The examination will be conducted by the respective College. The examination will be for 150 minutes and will contain 7 questions, with minimum one question from each module of which student should answer any five. Each question can carry 12 marks.

Model Question paper

AUDIT COURSE

223AGE001 – SYSTEM MODELLING

Answer any five questions Each carries 12 marks

PART A

1. a. Discuss the advantages and disadvantages of simulation. (5marks)
b. What are the areas of applications of simulation (7 marks)
2. a. A bus arrives every 20 minutes at a specified stop beginning at 6:40 A.M. and continuing until 8:40 A.M. A certain passenger does not know the schedule, but arrives randomly (uniformly distributed) between 7:00A.M. and 7:30 A.M. every morning. What is the probability that the passenger waits more than 5 minutes for a bus? (5 marks)
b. A production process manufactures computer chips on the average at 2% nonconforming. Every day, a random sample of size 50 is taken from the process. If the sample contains more than two nonconforming chips, the process will be stopped. Compute the probability that the process is stopped by the sampling scheme. (7 marks)
3. a. Discuss the different types of tests for random numbers. (5 marks)
b. Generate random numbers using multiplicative congruential method with $X_0 = 5$, $a = 11$, and $m = 64$. (7 marks)
4. a. What are the different methods of data collection. (4marks)
b. Records pertaining to the monthly number of job-related injuries at an underground coalmine were being studied by a federal agency. The values for the past 100 months were as follows:

Injuries per Month	Frequency of Occurrence
0	35
1	40
2	13
3	6
4	4
5	1
6	1



- (a) Apply the chi-square test to these data to test the hypothesis that the underlying distribution is Poisson. Use the level of significance $\alpha = 0.05$.
- (b) Apply the chi-square test to these data to test the hypothesis that the distribution is Poisson with mean 1.0. Again let $\alpha = 0.05$.
- c) What are the differences between parts (a) and (b), and when might each case arise? (8 marks)

5. a. What is the difference between validation and verification. (5 marks)
 b. Discuss the different measures of performance and their estimation. (7 marks)
6. a. Discuss the different methods of parameter estimation. (5 marks)
 b. With an example, describe the Poisson process. (7 marks)
7. a. Distinguish between discrete and continuous systems. (5 marks)
 b. What are the different components of a simulation system. (7 marks)

Syllabus

Module	Content	Hours	Semester Exam Marks (%)
I	When simulation is the appropriate tool. Advantages and disadvantages of Simulation; Areas of application, Systems and system environment; Components of a system; Discrete and continuous systems, Model of a system; Types of Models, Discrete-Event System Simulation, Steps of a simulation study.	6	20
II	Review of terminology and concepts, Useful statistical models, Discrete distributions. Continuous distributions, Poisson process, Empirical distributions. (basic idea only)	6	20
III	Properties of random numbers; Generation of pseudo-random numbers, Techniques for generating random numbers, Tests for Random Numbers	6	20
IV	Data Collection; Identifying the distribution with data, Parameter estimation, Goodness of Fit Tests, Fitting a non-stationary Poisson process, Selecting input models without data, Multivariate and Time-Series input models.	6	20
V	Measures of performance and their estimation, Output analysis for terminating simulations, Output analysis for steady-state simulations, Verification, calibration and validation	6	20



Course Plan

No	Topic	No. of Lectures
1	Introduction	
1.1	When simulation is the appropriate tool	1
1.2	Advantages and disadvantages of Simulation;	1
1.3	Areas of application, Systems and system environment;	1
1.4	Components of a system; Discrete and continuous systems,	1
1.5	Model of a system; Types of Models,	1
1.6	Discrete-Event System Simulation ,Steps of a simulation study	1
2	Statistical Models in Simulation	
2.1	Review of terminology and concepts, Empirical distributions. (basic idea only)	1
2.2	Useful statistical models,	1
2.3	Discrete distributions.	1
2.4	Continuous distributions,.	1
2.5	Poisson process	1
2.6	Empirical distributions	1
3	Random Number Generation	
3.1	Properties of random numbers;	1
3.2	Generation of pseudo-random numbers,	
3.3	Techniques for generating random numbers	1
3.4	Techniques for generating random numbers(cont)	1
3.5	Tests for Random Numbers	1
3.6	Tests for Random Numbers(cont)	1
4	Input Modelling	
4.1	Data Collection;	1
4.2	Identifying the distribution with data.	1
4.3	Parameter estimation, Goodness of Fit Tests	1
4.4	Fitting a non-stationary Poisson process	1
4.5	Selecting input models without data,	1
4.6	Multivariate and Time-Series input models	1
5	Measures of Performance and their Estimation	
5.1	Measures of performance and their estimation	1
5.2	Measures of performance and their estimation(cont)	1
5.3	Output analysis for terminating simulations	1
5.4	Output analysis for steady-state simulations	1
5.5	Verification, calibration and validation	1
5.6	Verification, calibration and validation(cont)	1



Textbooks:

1. Jerry Banks, John S. Carson II, Barry L. Nelson, David M. Nicol: Discrete-Event System Simulation, 5th Edition, Pearson Education, 2010.

Reference Books:

1. Lawrence M. Leemis, Stephen K. Park: Discrete – Event Simulation: A First Course, Pearson Education, 2006.

2. Averill M. Law: Simulation Modeling and Analysis, 4 th Edition, Tata McGraw-Hill, 2007

3. System Modelling and Response by Ernest O. Doebelin

4. Averill M Law, “Simulation Modeling and Analysis”,McGraw-Hill Inc,2007 Geoffrey Gorden, “System Simulation”,Prentice Hall of India,1992.

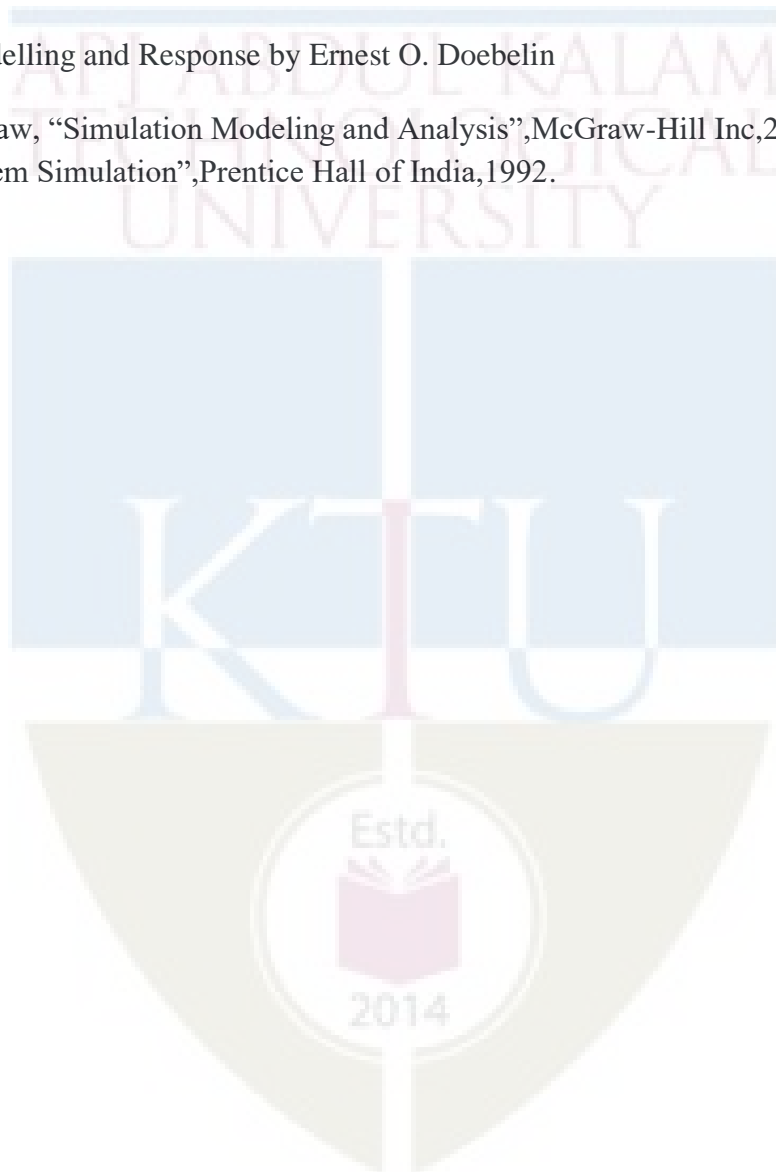

223AGE009	Principles of Automation	CATEGORY	L	T	P	CREDIT
		CREDIT COURSE	3	0	0	0

Preamble:

This course deals in detail with the various aspects of automation such as sensors, actuators, controllers, mechanical and electrical elements and their integration for automating new and existing manufacturing and process industries and applications. This course will be beneficial to students in designing automation schemes for industries and to design automated systems

Course Outcomes: After the completion of the course the student will be able to

CO 1	Explain the fundamentals of sensor systems and to choose a suitable sensor system for the given application based on the evaluation of the constraints.
CO 2	Explain the fundamentals of signal conditions and to design a suitable signal conditioning scheme for given application.
CO 3	Describe the characteristics of various actuator systems and to decide the right type of actuator for the given application.
CO 4	Describe the importance of an industrial robot and fundamentals of numerical control in automation.
CO 5	Explain the fundamentals of controllers used in industrial automation and to construct simple automation schemes by ladder logic programs.

Mapping of course outcomes with program outcomes

	PO 1	PO 2	PO 3	PO 4	PO 5	PO 6	PO 7
CO 1	2		2	2	2		
CO 2	2		2	2	2		
CO 3	2		2	2	2		
CO 4	2		2	2	2		
CO 5	2		2				

Assessment Pattern

Bloom's Category	End Semester Examination
Understand	70 %
Apply	30 %

Mark distribution

Total Marks	CIE	ESE	ESE Duration
100	40	60	2.5 hours



Continuous Internal Evaluation Pattern: 40 marks

Course based task (Project/Assignments/Simulations/Case studies): 15 marks

Seminar/Quiz: 15 marks

Test paper, 1 no.: 10 marks

Test paper shall include minimum 80% of the syllabus.

End Semester Examination Pattern:60 marks

The examination will be conducted by the respective College. The examination will be for 150 minutes and will contain 7 questions, with minimum one question from each module of which student should answer any five. Each question can carry 12 marks.

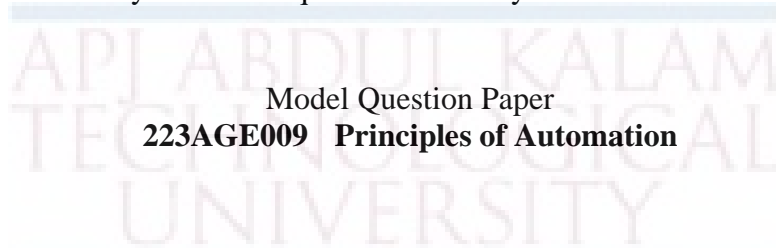

Model Question Paper

223AGE009 Principles of Automation

Time 2.5 Hrs

Marks 60

Answer any five questions Each carries 12 marks

1. (a) Differentiate the static and dynamic characteristics of a temperature sensor and explain how it affects the selection of a suitable temperature sensor. (6 marks)
(b) Explain the working of a strain-gauge. (6marks)
2. (a) Explain why anti-aliasing filters are used in analog to digital converters. (3 marks)
(b) Design a first order low pass filter with a cutoff frequency of 2 kHz. (9 marks)
3. (a) What are the factors to consider while deciding choosing between hydraulic, pneumatic or electrical actuation systems for an automation scheme? (4 marks)
(b) Explain the working of a three-way pressure reducing valve. (4 marks)
(c) Explain the working of solenoids. In what applications would you use a Solenoid valve. (4 marks)
4. (a) Explain the principle of the Touch sensor and also mention how they are used in robots. (5 marks)
(b) Explain the basic terminologies in robotic system and also explain the components of robotic system. (7 marks)
5. (a) With neat schematic explain the architecture of the PLC. (6 marks)
(b) Explain the use of an up-down counter in PLC with a suitable example. (6 marks)
6. (a) Write short note on SCADA. What is difference PLC and SCADA? (3 marks)
(b) Construct a ladder logic for controlling a process tank as per the logic given below;
i. The tank should be filled by a valve V1 when low level float switch L1 is ON and an external input S1 is received.



- ii. V1 should be closed when the liquid level reaches a high-level float switch L2.
 - iii. An agitator motor should be turned on after a delay of 5sec after L2 is triggered.
 - iv. After agitating for 30mins, contents of the tank should be emptied by opening another valve V2.
 - v. The temperature should be maintained at 70°C using a thermostat T1 and Heater H
(9 marks)
7. (a) Explain the levels of Automation. (6 marks)
(b) Explain the working of Flow sensor (6 marks)

Syllabus and Course Plan

No	Topics	No. of Lectures
1	Introduction to Industrial Automation	
1.1	Basic Elements of an Automated System, Levels of Automation	2
1.2	Hardware components for Automation: Sensors, classification, Static and dynamic behaviour of sensors.	2
1.3	Basic working principle of different sensors: Proximity sensors, Temperature sensors, flow sensors, Pressure sensors, Force sensors. Position sensors	4
2	Signal conditioning	
2.1	Need for signal conditioning, Types of signal conditioning.	2
2.2	Signal conditioning using operational amplifier-Amplifier (Inverting and Non-inverting) and Filter circuits (Basic concepts). Design of first order low pass filter.	2
2.3	Signal conditioning for data acquisition systems, anti-aliasing filters, Analog-Digital Conversions, Analog-to-Digital Converters (ADC)- Steps in analog-to-digital conversion, Successive Approximation Method, Digital-to-Analog Converters (DAC)- Steps in digital to analog conversion, Zero-order and first order data hold circuits	4
3	Actuators	
3.1	Types of actuators- mechanical, electrical, pneumatic and hydraulic actuators. (Basic working principle)	2
3.2	Mechanical systems for motion conversion, transmission systems	3
3.3	Solenoids, Electric and stepper motors control.	3
4	Robotics and Automated Manufacturing Systems	
4.1	Robot Anatomy and Related Attributes: Joints and Links, Common Robot Configurations, Joint Drive Systems, Sensors in Robotics (Basic concepts)	3
4.2	Robot Control Systems, Applications of Industrial Robots- Material handling	4
4.3	Fundamentals of Numerical control (NC) Technology	1
5	Discrete Control and Programmable Logic Controllers	



5.1	Discrete Process Control: Logic and Sequence control	2
5.2	Ladder Logic Diagrams, Programmable Logic Controllers: Components of the PLC, PLC Operating Cycle, Programming the PLC (Basic concepts only)	4
5.3	Introduction to Distributed control system (DCS) and Supervisory Control and Data Acquisition Systems (SCADA)	2

Reference Books

1. Mikell Groover, Automation, Production Systems, and Computer-Integrated Manufacturing, 5th Edition, Pearson, 2019.
2. Yoram Koren, "Computer Control of Manufacturing Systems", TataMcGraw Hill Edition 2005.
3. S. R. Deb; Sankha Deb. Robotics Technology and Flexible Automation, Second Edition McGraw-Hill Education: New York, 2010.
4. W. Bolton, "Mechatronics: Electronic Control Systems in Mechanical and Electrical Engineering" - PrenticeHall- 2013 - 5th Edition.
5. Doebelin, E.O. and Manic, D.N., "Measurement Systems: Applications and Design", 7th Edition, McGraw Hill, 2019.
6. Krishna Kant, Computer Based Industrial Control-, EEE-PHI, 2nd edition, 2010.
7. Nathan Ida, Sensors, Actuators, and Their Interfaces- A multidisciplinary introduction, 2nd Edition, IET Digital Library, 2020.
8. Salivahanan, S., and VS Kanchana Bhaaskaran. Linear integrated circuits. McGraw-Hill Education, 2nd edition, 2014.
9. Petruzella, Frank D. Programmable logic controllers. Tata McGraw-Hill Education, 2005
10. Chapman and Hall, "Standard Handbook of Industrial Automation", Onsidine DM C & Onsidine GDC", NJ, 1986

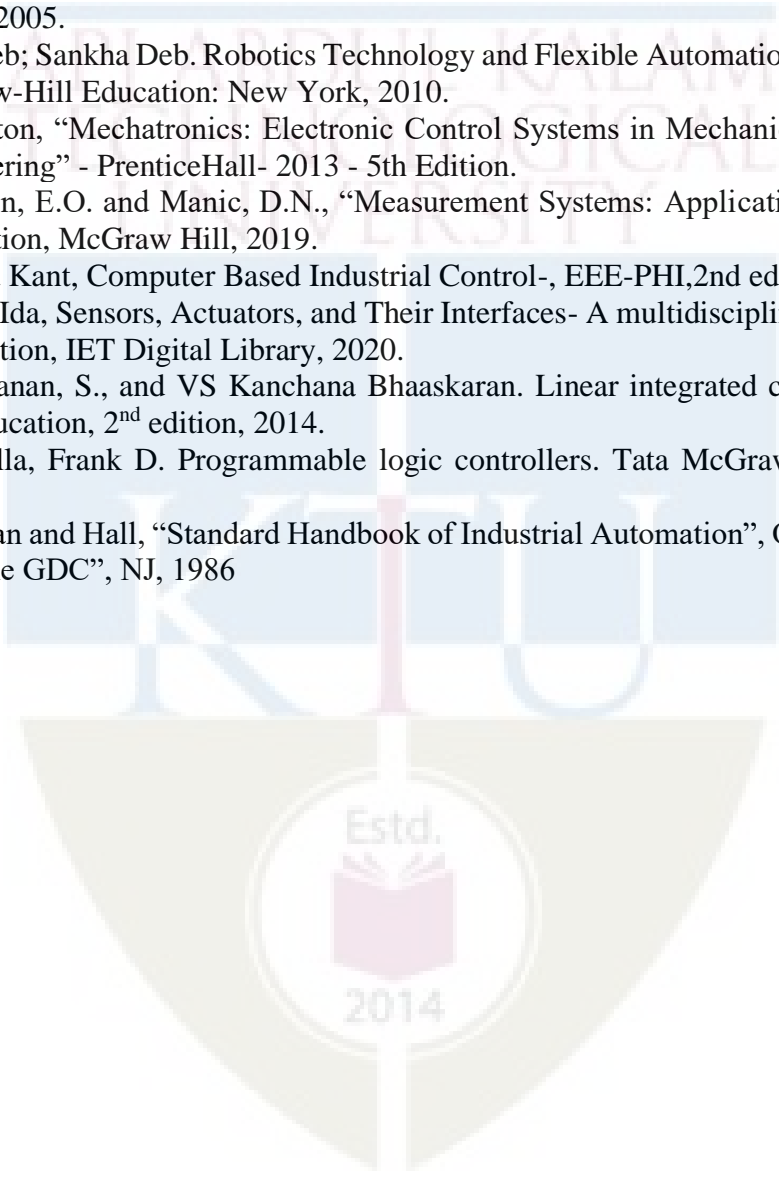

223AGE002	FORENSIC ENGINEERING	CATEGORY	L	T	P	CREDIT
		Audit Course	3	0	0	-

Preamble: This course explores various aspects of Forensic Engineering and different methods ,tools and procedures used by Engineers to investigate and analyze . The students will learn to develop their awareness in Forensic Engineering .

Pre-requisite: Nil

Course Outcomes:

After the completion of the course the student will be able to

CO 1	Identify the fundamental aspects of forensic Engineering
CO 2	Apply forensic Engineering in Practical work flow and Investigation
CO 3	Apply methods and analysis in Forensic Investigation
CO 4	Develop practical strategies and standards of Investigation
CO 5	Create an awareness in criminal cases and create Engineering expertise in court room on forensic Engineering

Mapping of course outcomes with program outcomes

	PO 1	PO 2	PO 3	PO 4	PO 5	PO 6	PO7
CO 1	2	2	3	3	3	3	
CO 2	2	2	3	3	3	3	1
CO 3	3	3	3	3	3	3	1
CO 4	3	3	3	3	3	3	1
CO 5	3	3	3	3	3	3	

Assessment Pattern

Bloom's Category	Continuous Internal Evaluation	End Semester Examination
Apply	40 %	60 %
Analyse	40 %	40 %
Evaluate	20 %	

Mark distribution

Total Marks	CIE	ESE	ESE Duration
100	40	60	2.5 hours

Continuous Internal Evaluation: 40 marks

Course based task :15marks
 Seminar/Quizz :15marks
 Test paper :10 marks
 Test paper shall include minimum 80% of the syllabus.



End Semester Examination: 60 marks

The examination will be conducted by the respective College. The examination will be for 150 minutes and will contain 7 questions, with minimum one question from each module of which student should answer any five. Each question can carry 12 marks.

Model Question paper
APJ ABDUL KALAM TECHNOLOGICAL UNIVERSITY
THIRD SEMESTER M. TECH DEGREE EXAMINATION

Course Code: 223AG002

Course Name: FORENSIC ENGINEERING

Max. Marks: 60

Duration: 2.5 Hours

PART A

Answer any 5 questions, each question carries 12 marks.

Marks

- | | | |
|----|---|------|
| 1. | (a) What are the uses of forensic engineering in legal laws ? | (7) |
| | (b) Discuss the professional responsibility of a forensic Engineer . | (5) |
| 2. | (a) What are the steps in preliminary on site Investigation ? | (7) |
| | (b) With suitable examples, explain photo cataloguing? | (5) |
| 3. | (a) Discuss STEP method . | (7) |
| | (b) Explain root cause Analysis | (5) |
| 4. | (a) Detail about EDAX Method. | (7) |
| | (b) Enlist the uses of NDT in forensic Analysis with example | (5) |
| 5. | (a) Differentiate NFPA & FMV Standards | (7) |
| | (b) Briefly discuss the term Email Phishing ? | (5) |
| 6. | Define the responsibility and duty of a forensic expert in the court. | (12) |
| 7. | Explain Forensic Engineering workflow with examples | (12) |



Syllabus and Course Plan

Module No	Topic	No. of Lectures (Hours)
1	Module 01: Introduction to Forensic Engineering (6 Hours)	
1.1	Forensic Engineering-Definition, Investigation Pyramid, Eyewitness Information, Role in Legal System	2
1.2	Scientific Method-Applying scientific methods in Forensic Engineering-Engineer as expert Witness-Scientific methods and legal system	2
1.3	Qualification of Forensic Engineer-Technical- Knowledge- Oral-written-Communication- other skills-Personality Characteristics	1
1.4	Ethics and professional responsibilities.	1
2	Module 02: Forensic Engineering Workflow and Investigation Methods (6 Hours)	
2.1	Forensic Engineering Workflow-Team & planning-preliminary onsite investigation. Sampling-selection of sample-collection- packing-sealing of samples.	2
2.2	Source and type of evidence - Paper documentation- digital documentation-electronic data. Physical Evidence-Collection of photograph-cataloguing -Recognizing the Evidence-organizing-Evidence Analysis -Reporting	2
2.3	Investigation Methods- Cause and Causal mechanism analysis-Time and event sequence-STEP method. Human Factors, Human errors - Analysis of Operative Instruction and working Procedures	2
3	Module 03: Physical Product Failure & Analytical Methods (6 Hours)	
3.1	Introduction to typical Forensic Engineering Tool box-NDT, Crack detection and human eye -Hardness testing- and Destructive testing Methods with case studies	2
3.2	Indirect stress strain Analysis-Brittle lacquer technique, Contact Radiography-Metallography-EDAX method	1
3.3	Forensic Optical Microscopy-Examination- Magnification-USB Microscopy -Wifi Enabled microscopy -Reflected microscopy	2
3.4	Novel Tools and System -Contour Method-Flash Thermography-Thermographic signal reconstruction (TSR)-Electromagnetically induced acoustic Emission (EMAE)-Pulsed Eddy Current (PEA)-Theory only	1
4	Module 04: Cyber Forensic , Civil ,Electrical Accidents & Standards (6 Hours)	
4.1	Basics of Digital & Cyber forensics: Technical concepts; labs and tools; collecting evidence Operating System Forensic basics with - Windows, Linux -Mobile Forensic-Anti forensics-Malware- Web attack forensics with Email Crimes-Cyber Laws	3
4.2	Different types of Forensic accident investigations- Civil Engineering-Structural- Road accidents -Fire accidents - Water related accidents- Electrical accidents and Investigation methods	2
4.3	Protocol for forensic Investigations-Standard guides-scope significance - use -procedures- reports. Standards – ASTM standards -FMV Standards -SAE Standards -Relevant Standards -NFPA Standards -International Standards	1



5	Module 05: Engineer in the Court room& Criminal Cases (6 Hours)	
5.1	Role of an Engineering Expert-Report-pre trial meetings-Alternative dispute resolution-Single joint expert. Engineer in the court room	2
5.2	Criminal Cases-Introduction-Counterfeit coins-fraudulent road accidents-Fraudulent Insurance claims.	2
5.3	Cyber Crimes and Cases- SIM Swapping -ATM Cloning-Microsoft Internal Spam- Intellectual property cases.	2

Reference Books

1. Colin R Gagg, *Forensic Engineering The Art & Craft of a failure detective* , Taylor & Francis Publishing, 2020
2. Luca Fiorentini ,Luca Marmo *Principles of Forensic Engineering Applied to Industrial Accidents* , Wiley, 2019
3. Harold Franck, Darren Franck , *Forensic Engineering Fundamentals* ,Taylor & Francis publishing 2013
4. Randall K Noon , *Forensic Engineering Investigation*, CRC press limited , 2001
5. Stephen E Petty , *Forensic Engineering: Damage assessment for residential and commercial structures* CRC press 2nd edition , 2017
6. Joshua B Kardon , *Guideliness for forensic Engineering practice* , ASCE, 2012
7. Richard W. Mclay and Robert N. Anderson, *Engineering standards for forensic Applications* , Academic Press; 1st edition 2018
8. Max M Houck ,*Forensic Engineering (Advanced forensic Science)* , Academic press 1st edition 2017
9. Niranjana Reddy - Practical Cyber Forensics. *An Incident-based Approach to Forensic Investigations-Apress (2019)*
10. Peter Rhys Lewis, Ken Reynolds, Colin Gagg - *Forensic Materials Engineering Case Studies- CRC Press (2003) (1)*



INTERNSHIP

A student shall opt for carrying out the Internship at an Industry/Research Organization or at another institute of higher learning and repute (Academia). The organization for Internship shall be selected/decided by the students on their own with prior approval from the faculty advisor/respective PG Programme Coordinator/Guide/Supervisor. Every student shall be assigned an internship Supervisor/Guide at the beginning of the Internship. The training shall be related to their specialisation after the second semester for a minimum duration of six to eight weeks. On completion of the course, the student is expected to be able to develop skills in facing and solving the problems experiencing in the related field.

Objectives

- Exposure to the industrial environment, which cannot be simulated in the classroom and hence creating competent professionals for the industry.
- Provide possible opportunities to learn understand and sharpen the real time technical / managerial skills required at the job.
- Exposure to the current technological developments relevant to the subject area of training.
- Create conducive conditions with quest for knowledge and its applicability on the job.
- Understand the social, environmental, economic and administrative considerations that influence the working environment.
- Expose students to the engineer's responsibilities and ethics.

Benefits of Internship

Benefits to Students

- An opportunity to get hired by the Industry/ organization.
- Practical experience in an organizational setting & Industry environment.
- Excellent opportunity to see how the theoretical aspects learned in classes are integrated into the practical world. On-floor experience provides much more professional experience which is often worth more than classroom

teaching.

- Helps them decide if the industry and the profession is the best career option to pursue.
- Opportunity to learn new skills and supplement knowledge.
- Opportunity to practice communication and teamwork skills.
- Opportunity to learn strategies like time management, multi-tasking etc in an industrial setup.
- Makes a valuable addition to their resume.
- Enhances their candidacy for higher education/placement.
- Creating network and social circle and developing relationships with industry people.
- Provides opportunity to evaluate the organization before committing to a full time position.

Benefits to the Institute

- Build industry academia relations.
- Makes the placement process easier.
- Improve institutional credibility & branding.
- Helps in retention of the students.
- Curriculum revision can be made based on feedback from Industry/ students.
- Improvement in teaching learning process.

Benefits to the Industry

- Availability of ready to contribute candidates for employment.
- Year round source of highly motivated pre-professionals.
- Students bring new perspectives to problem solving.
- Visibility of the organization is increased on campus.

- Quality candidate's availability for temporary or seasonal positions and projects.
- Freedom for industrial staff to pursue more creative projects.
- Availability of flexible, cost-effective workforce not requiring a long-term employer commitment.
- Proven, cost-effective way to recruit and evaluate potential employees.
- Enhancement of employer's image in the community by contributing to the educational enterprise.

Types of Internships

- Industry Internship with/without Stipend
- Govt / PSU Internship (BARC/Railway/ISRO etc)
- Internship with prominent education/research Institutes
- Internship with Incubation centres /Start-ups

Guidelines

- All the students need to go for internship for minimum duration of 6 to 8 weeks.
- Students can take mini projects, assignments, case studies by discussing it with concerned authority from industry and can work on it during internship.
- All students should compulsorily follow the rules and regulations as laid by industry.
- Every student should take prior permissions from concerned industrial authority if they want to use any drawings, photographs or any other document from industry.
- Student should follow all ethical practices and SOP of industry.
- Students have to take necessary health and safety precautions as laid by the industry.
- Student should contact his /her Guide/Supervisor from college on weekly basis to communicate the progress.
- Each student has to maintain a diary/log book
- After completion of internship, students are required to submit
 - Report of work done
 - Internship certificate copy
 - Feedback from employer / internship mentor
 - Stipend proof (in case of paid internship).

Total Marks 100: The marks awarded for the Internship will be on the basis of (i) Evaluation done by the Industry (ii) Students diary (iii) Internship Report and (iv) Comprehensive Viva Voce.

Continuous Internal Evaluation: 50 marks

Student's diary - 25 Marks

Evaluation done by the industry - 25 Marks

Student's Diary/ Daily Log: The main purpose of writing daily diary is to cultivate the habit of documenting and to encourage the students to search for details. It develops the students' thought process and reasoning abilities. The students should record in the daily training diary the day to day account of the observations,

impressions, information gathered and suggestions given, if any. It should contain the sketches & drawings related to the observations made by the students. The daily training diary should be signed after every day by the supervisor/ in charge of the section where the student has been working. The diary should also be shown to the Faculty Mentor visiting the industry from time to time and got ratified on the day of his visit. Student's diary will be evaluated on the basis of the following criteria:

- Regularity in maintenance of the diary
- Adequacy & quality of information recorded
- Drawings, design, sketches and data recorded
- Thought process and recording techniques used
- Organization of the information.

The format of student's diary

Name of the Organization/Section:

Name and Address of the Section Head:

Name and Address of the Supervisor:

Name and address of the student:

Internship Duration: From To

Brief description about the nature of internship:

Day	Brief write up about the Activities carried out: Such as design, sketches, result observed, issues identified, data recorded, etc.
1	
2	
3	

Signature of Industry Supervisor

Signature of Section Head/HR Manager

Office Seal

Attendance Sheet

Name of the Organization/Section:

Name and Address of the Section Head:

Name and Address of the Supervisor:

Name and address of the student:

Internship Duration: From To

Month & Year	1	2	3	4	5	6	7	8	9	10	11	12	13	14	15	16	17	18	19	20	...	
Month & Year																						
Month & Year																						
Month & Year																						
Month & Year																						

Signature of Industry Supervisor

Signature of Section Head/HR Manager

Office Seal

Note:

- Student's Diary shall be submitted by the students along with attendance record and an evaluation sheet duly signed and stamped by the industry to the Institute immediately after the completion of the training.
- Attendance Sheet should remain affixed in daily training diary. Do not remove or tear it off.
- Student shall sign in the attendance column. Do not mark 'P'.
- Holidays should be marked in red ink in the attendance column. Absent should be marked as 'A' in red ink.

Evaluation done by the Industry (Marks 25)

Format for Supervisor Evaluation of Intern

Student Name : _____ Date: _____

Supervisor Name : _____ Designation: _____

Company/Organization : _____

Internship Address: _____

Dates of Internship: From _____ To _____

Please evaluate intern by indicating the frequency with which you observed the following parameters:

Parameters	Marks	Needs improvement (0 – 0.25 mark)	Satisfactory (0.25 – 0.50 mark)	Good (0.75 mark)	Excellent (1 mark)
Behavior					
Performs in a dependable Manner					
Cooperates with coworkers and supervisor					
Shows interest in work					
Learns quickly					
Shows initiative					
Produces high quality work					
Accepts responsibility					
Accepts criticism					
Demonstrates organizational skills					
Uses technical knowledge and expertise					
Shows good judgment					
Demonstrates creativity/originality					
Analyzes problems effectively					
Is self-reliant					
Communicates well					
Writes effectively					
Has a professional attitude					
Gives a professional appearance					
Is punctual					
Uses time effectively					

Overall performance of student

Intern (Tick one) : Needs improvement (0 - 0.50 mark) / Satisfactory (0.50 – 1.0 mark) / Good (1.5 mark) / Excellent (2.0 mark)

Additional comments, if any (2 marks):

Signature of Industry Supervisor

Signature of Section Head/HR Manager

Office Seal

End Semester Evaluation (External Evaluation): 50 Marks

Internship Report - 25 Marks

Viva Voce - 25 Marks

Internship Report: After completion of the internship, the student should prepare a comprehensive report to indicate what he has observed and learnt in the training period and should be submitted to the faculty Supervisor. The student may contact Industrial Supervisor/ Faculty Mentor for assigning special topics and problems and should prepare the final report on the assigned topics. Daily diary will also help to a great extent in writing the industrial report since much of the information has already been incorporated by the student into the daily diary. The training report should be signed by the Internship Supervisor, Programme Coordinator and Faculty Mentor.

The Internship report (25 Marks) will be evaluated on the basis of following criteria:

- Originality
- Adequacy and purposeful write-up
- Organization, format, drawings, sketches, style, language etc.
- Variety and relevance of learning experience
- Practical applications, relationships with basic theory and concepts taught in the course

Viva Voce (25 Marks) will be done by a committee comprising Faculty Supervisor, PG Programme Coordinator and an external expert (from Industry or research/academic Institute). This committee will be evaluating the internship report also.

RESEARCH PROJECT/DISSERTATION

Research Project: Students choosing track 2 shall carry out the research project in their parent Institution only under the guidance of a supervisor assigned by the DLAC.

Dissertation: All categories of students in track 1 are to carry out the dissertation in the Institute they are studying or can work either in any CSIR/Industrial R&D organization/any other reputed Institute which have facilities for dissertation work in the area proposed.

Mark Distribution:

Phase 1: Total marks: 100, only CIA

